

ACO Building Drainage

ACO 8in HYGIENIC FLOOR DRAIN, ADJUSTABLE - LOCATION FLANGE, 2in HORIZONTAL OUTLET

ACO Specification Information

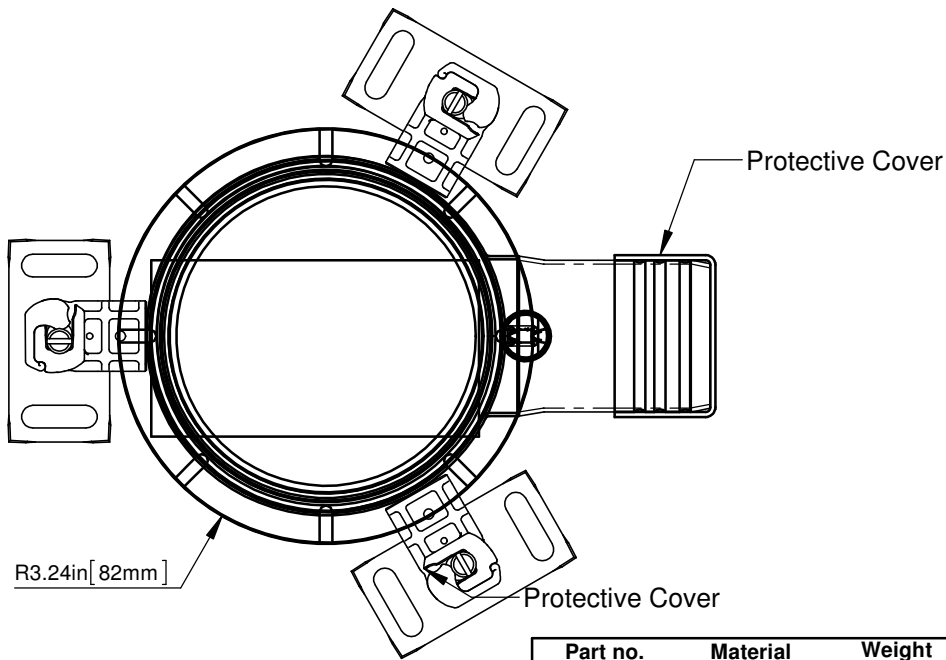
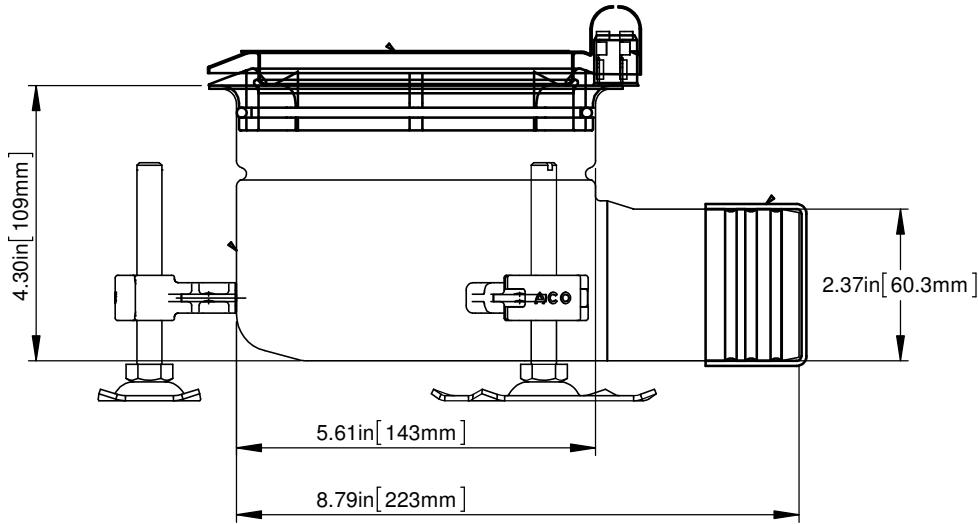

Part no.	Material	Weight lbs.	Flow Rate GPM*
445258	AISI 304	3.8	36.9 / 39.4
445294	AISI 316L	3.8	36.9 / 39.4

Specification Clause

ACO 8" Hygienic Floor Drain with 2in horizontal outlet. Made from AISI 304 or AISI 316L. Uses ACO 8" Hygienic Floor Top. Flow Rates calculated from maximum and minimum height positions. Certified to NSF/ANSI/3-A Standard 14159-1.

ACO recommends checking local plumbing codes prior to installation.

ACO Polymer Products, Inc.

Northeast Sales Office
 9470 Pinecone Dr.
 Mentor, OH 44060
 Tel: (440) 639-7230
 Toll Free: (800) 543-4764
 Fax: (440) 639-7235

West Sales Office
 825 W Beechcraft St.
 Casa Grande, AZ 85122
 Tel: (520) 421-9988
 Toll Free: (866) 809-4506
 Fax: (520) 421-9899

Southeast Sales Office
 4211 Pleasant Road
 Fort Mill, SC 29708
 Tel: (800) 543-4764
 Toll Free: (800) 543-4764
 Fax: (803) 802-1063

Follow us on



Electronic Contact:
 info@acousa.com
 www.acobuildingdrainage.us



May 2016 ACO Polymer Products, Inc. This information is believed to be accurate but it is not guaranteed to be so. We cannot assume liability for results that buyer obtains with our products since conditions of use are beyond the control of the company. It is the customer's responsibility to evaluate suitability and safety of product for his own use. ACO Polymer Products, Inc. reserves the right to change the product and specifications without notice.