

ACO Building Drainage

ACO 8in HYGIENIC FLOOR DRAIN, ADJUSTABLE - MECH. CLAMPING FLANGE, 4in VERTICAL OUTLET

ACO Specification Information

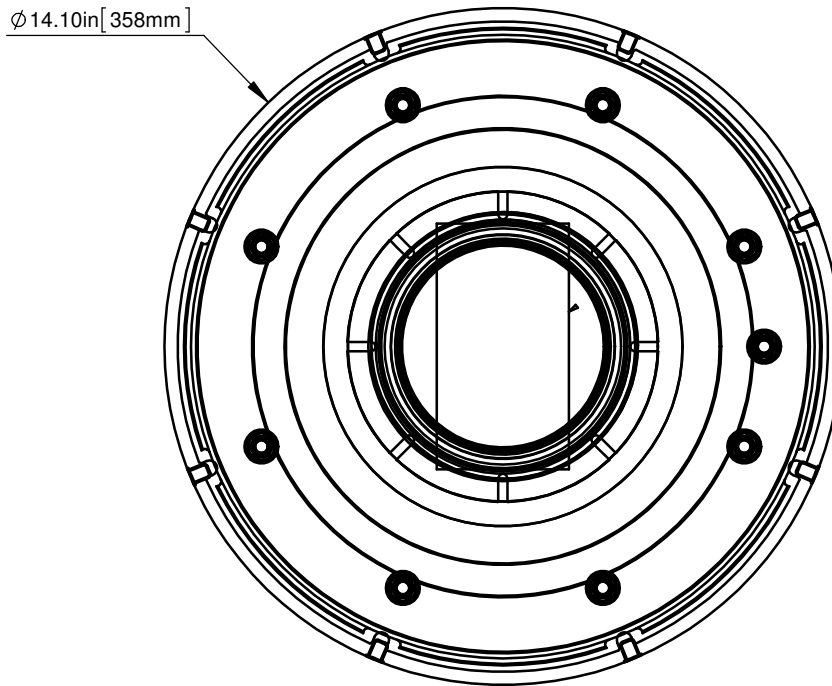
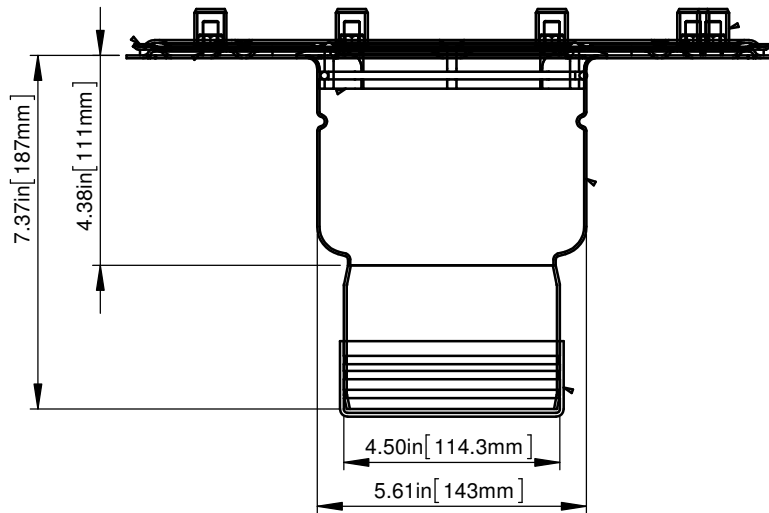

| Part no. | Material | Weight lbs. | Flow Rate GPM* |
|----------|-----------|-------------|----------------|
| 445256 | AISI 304 | 8.5 | 147.4 / 155.4 |
| 445292 | AISI 316L | 8.5 | 147.4 / 155.4 |

Specification Clause

ACO 8" Hygienic Floor Drain with 4in vertical outlet. Made from AISI 304 or AISI 316L. Uses ACO 8" Hygienic Floor Top. Flow Rates calculated from maximum and minimum height positions. Certified to NSF/ANSI/3-A Standard 14159-1.

ACO recommends checking local plumbing codes prior to installation.

ACO Polymer Products, Inc.

Northeast Sales Office
9470 Pinecone Dr.
Mentor, OH 44060
Tel: (440) 639-7230
Toll Free: (800) 543-4764
Fax: (440) 639-7235

West Sales Office
825 W Beechcraft St.
Casa Grande, AZ 85122
Tel: (520) 421-9988
Toll Free: (866) 809-4506
Fax: (520) 421-9899

Southeast Sales Office
4211 Pleasant Road
Fort Mill, SC 29708
Tel: (800) 543-4764
Toll Free: (800) 543-4764
Fax: (803) 802-1063

Follow us on



Electronic Contact:
info@acousa.com
www.acobuildingdrainage.us



May 2016 ACO Polymer Products, Inc. This information is believed to be accurate but it is not guaranteed to be so. We cannot assume liability for results that buyer obtains with our products since conditions of use are beyond the control of the company. It is the customer's responsibility to evaluate suitability and safety of product for his own use. ACO Polymer Products, Inc. reserves the right to change the product and specifications without notice.