

ACO Floor Drain Unit - Fixed Height

Installation manual



ACO Floor Drain Unit - Fixed Height

Examples:



Horizontal outlet



Vertical outlet

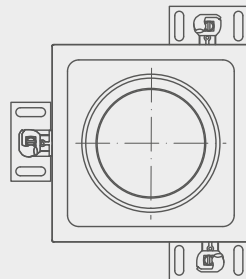
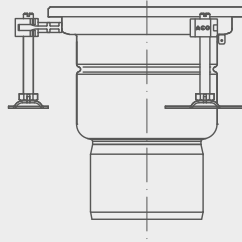
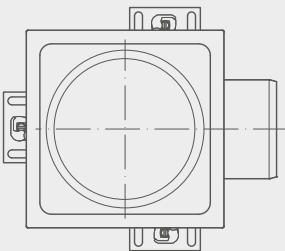
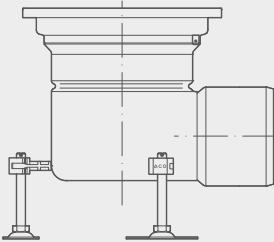

Assembly of leveling feet for installation



Attach red plastic clips.



Use rubber/plastic hammer to securely fix clip in place.



Open clip.



Insert leveling feet through plastic clip.



Leveling feet slide through clip to set unit at approximate height and level required.



Close and snap clip to hold feet in place - fine tuning can be done later with screwdriver.

ACO Floor Drain Unit - Fixed Height

Horizontal outlet shown - follow same procedure for vertical outlet



Fit outlet pipe to floor drain - apply lubricant and simultaneously push and twist to prevent damage to seal in pipe.

Alternately, use hubless coupler if other non-ACO Pipe system used.

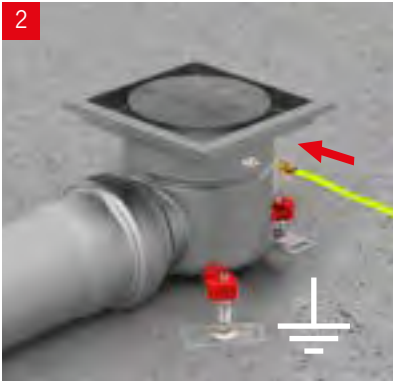

Attach grounding wire to earthing point on the floor drain, if required.



Secure leveling feet to footer, if desired, to prevent movement during concrete pour.

Installation of fixed height floor drain in concrete slab



4



Check height and level - adjust, if needed, using screwdriver in the top of leveling feet.

5



Set floor drain in concrete haunch - take care not to dislodge earthing wire.

6

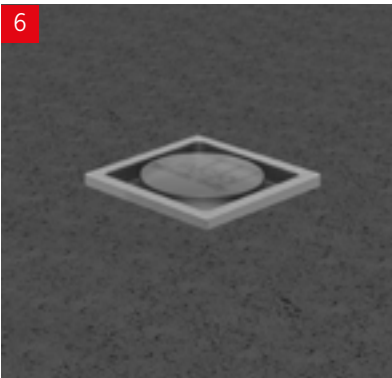

Finish concrete surface to required level. Leave height difference if additional floor covering is required.

ACO Floor Drain Unit - Fixed Height

Finishing floor

Screed floor



Tiled floor

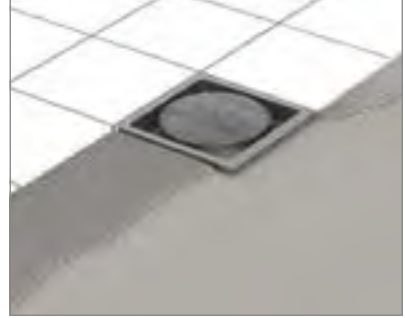

Install floor finish - ensure 1/8" (3mm) above floor drain to ensure positive drainage.

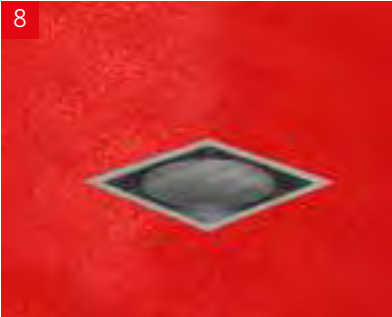

Clean floor and remove site debris before removing floor drain cover to prevent debris washing into floor drain.



Remove protective floor drain cover.



10



Install required grate.



11

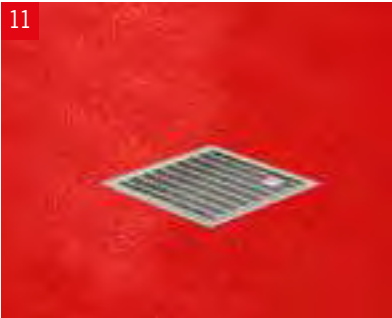

Installation is complete. Ensure regular maintenance and cleaning is performed to ensure long service life.

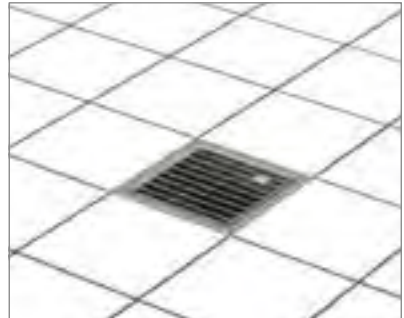

Other Installation manuals:

Modular Channels



ACO Floor Drain - Adjustable Height



Floor Drain Top and Floor Trough



ACO Polymer Products, Inc.

West Sales Office

825 W. Beechcraft St.
Casa Grande, AZ 85122
Tel: (520) 421-9988
Toll Free: (888) 490-9552
Fax: (520) 421-9899

Northeast Sales Office

9470 Pinecone Drive
Mentor, OH 44060
Tel: (440) 639-7230
Toll Free: (800) 543-4764
Fax: (440) 639-7235

Southeast Sales Office

4211 Pleasant Road
Fort Mill, SC 29708
Toll Free: (800) 543-4764
Fax: (803) 802-1063

Electronic Contact:

info@acousa.com
www.acobuildingdrainage.us

Follow us on:



© July 2017 ACO Polymer Products, Inc.

All reasonable care has been taken in compiling the information in this document. All recommendations and suggestions on the use of ACO products are made without guarantee since the conditions of use are beyond the control of the Company. It is the customer's responsibility to ensure that each product is fit for its intended purpose and that the actual conditions of use are suitable. ACO Polymer Products, Inc. reserves the right to change products and specifications without notice.

Re-order Part # NM10275