



ACO Building Drainage



STAINLESS STEEL PIPE BROCHURE

Stainless steel, gravity, push-fit pipe systems

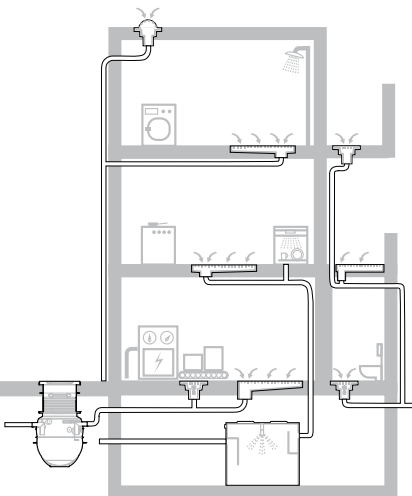

ACO Building Drainage

ACO offers drainage systems designed to protect your business and the environment. The stainless steel floor drainage products in the Building Drainage product line are designed for ultimate hygienic and corrosion resistant performance, ensuring health & safety of workers, customers and products while still allowing clean-in-place functionality.

Product Portfolio

- **Stainless Steel Trench Drains**
versatile, modular stainless steel drainage
- **Floor Drains**
stainless steel floor drains
- **Hygienic Stainless Steel Box Drains**
stainless steel drainage for commercial kitchens or food applications
- **Pipe**
gravity fed stainless steel push-fit pipe
- **BuildLine**
green roof, perimeter and threshold drainage
- **QuARTz ShowerDrain**
stainless steel bathroom drainage



ACO Pipe®

ACO has developed a range of stainless steel pipe systems for multi-drainage applications.

ACO Pipe® stainless steel push-fit pipe systems provide the modern metal alternative to PVC and HDPE soil and waste pipework. The range is completely compatible with ACO floor drains, channel systems and stormwater drainage products, which make up the complete portfolio for building drainage.

ACO Pipe® is manufactured from authentic stainless steel, grades 304 or 316L. All products are chemically pickled and passivated for optimum durability and corrosion resistance.

ACO Pipe® pipes and fittings are available in 50 mm (2"), 75 mm (3"), 110 mm (4"), 125 mm (5"), 160 mm (6") and 200 mm (8") (external diameters) with pipes supplied as standard from 6" (0.15 m) up to 19.8' (6 m) lengths for optimum practicality and ease of assembly. 1.57" (40 mm), 10" (250 mm) and 12.40" (315 mm) diameter pipes are made to order.

Typical applications

- *Petrochemical*
- *Commercial kitchens*
- *Food processing facilities*
- *Brewing, bottling and canning plants*
- *Chilled warehouses*
- *Laboratories*
- *Chemical industries*
- *Pharmaceutical industries*
- *Restaurants*
- *Schools*
- *Hospitals*
- *Hotels*



Industrial & Hygienic applications

For applications where resistance to chemicals, steam and heat are a priority, ACO Pipe® offers a reliable and durable solution.

Common industrial applications for ACO Pipe® include food, beverage, pharmaceutical, sanitary and sewage & water processing industries. All elements of ACO Pipe® systems are precisely produced to focus on high resistance to aggressive environments. With extensive industry experience—including R&D, advanced manufacturing, material processing and unique push-fit offering—ACO Pipe® systems ensure long service life and reliability.

For applications where hygiene is a priority, such as commercial kitchens, food processing facilities or hospitals, ACO offers stainless drainage solutions to address these demanding environments. ACO's goal is to improve every aspect of safety, hygiene and functional performance. In food processing and commercial kitchen environments, hot water, grease and organic waste must be counteracted by more complex and sophisticated drainage concepts.

Hygiene**First**

Our HygieneFirst philosophy represents our commitment to delivering products that provide ultimate hygienic performance. The ACO Pipe® hygienic stainless steel design is a solution that minimizes operational costs without compromising food safety.

Marine applications

In marine applications, the unique double-sealing system of ACO Pipe® provides a trouble free and reliable seal. Its quick and easy assembly—along with the stainless steel push-fit system—makes it the ideal solution for both new ship building or renovations and repairs. Stainless steel pipe systems are particularly suited to applications subject to thermal shock. The flexible rubber in the seals and hanging brackets help dampen constant vibrations and reduce system failure.

Table of Contents

| | |
|--------------------------------|----|
| Key Benefits | 4 |
| Features | 6 |
| Project Planning | 8 |
| Product Range - Pipe | 12 |
| Product Range - Fittings | 14 |
| Installation | 20 |
| Care and Maintenance | 25 |
| Seal Material Data | 26 |

Stainless Steel Pipework

The ACO Building Drainage name is synonymous with the highest standards in design and range diversity. Its stainless steel composition is ideal for industrial, commercial and architectural drainage systems.

As part of a growing range of engineered drainage solutions, ACO Pipe® presents a wide range of socket and spigot waste pipework systems in thin-wall stainless steel for above and below-ground drainage applications.

ACO Pipe® is non-pressurized. It has been designed, produced and tested for use in soil, waste, rainwater, and industrial wastewater drainage applications.

ACO Pipe® offers a unique push-fit feature designed for ease of assembly, reliable connection and accurate installation, Providing the modern metal alternative to PVC-u and cast iron soil and waste pipework.

ACO Pipe® installed with ACO floor drains and stainless steel channels complete a whole system of sustainable drainage solutions with unique advantages to customers.

All ACO Pipe® interconnecting seals and fittings incorporate a unique double-sealing system providing a trouble-free, reliable sealing system every time.

The wide range of available fittings have been developed using cold-forming techniques. This advanced technology minimizes the amount of welded components and provides definitive system reliability.



Advantages of Stainless Steel Pipe

- Resistant to thermal expansion
- Does not sag like PVC and CPVC
- Fire resistant
- Animal (rodent) proof [See page 19](#)
- Durable
- Lightweight
- Flexible material - Less potential for catastrophic failure (flooding) due to impact damage. Tends to result in bending rather than breakage/flooding.
- 100% recyclable

Reaction to Fire

ACO Pipe® push-fit system is designed and manufactured to EN 1124 Parts 1 & 2. It is non-combustible and classified as Class A "No contribution to fire" as provided for in Commission Decision 96/603/EC as amended.

ACO Pipe® systems are also certified by the Swedish Institute for Technical Approval in Construction (SITAC) as fire resistant, Certificate No 0410-01.

- Non-combustible
- No additional fire collars needed at installation
- No toxic fumes emitted in case of fire
EN 1124, SITAC, CSI, DNV and ABS fire certification available

Choosing the Right System

1 Environment - Corrosion

Stainless steel ACO Pipe® is offered in non-magnetic austenitic stainless steel (Grade 304 or 316L). All products are pickled and passivated; parts can be electropolished to special order.

Typical factors that affect material selection:

- Types of chemicals
- Concentration percentages
- Contact time
- Temperatures of liquids

Post Fabrication Processes



Heat from welding often causes surface discoloration. The material is no longer as corrosion resistant and is likely to rust and deteriorate.

Bead blasting and/or sanding can restore the aesthetics of the material but does not restore corrosion resistance



- a chemical process, such as pickling and passivation is needed. Fabrication processes such as cutting and bending can embed iron particles into the stainless steel - pickling and passivation will also remove these impurities.

Certification to confirm chemical resistance are available, contact ACO.

2 Environment - Temperature

Applications with high ambient or high fluid temperatures are ideal for stainless steel pipe systems as they offer a low coefficient of thermal expansion.

Thermal Movement

A comparison of approximate thermal movement between different pipe materials (in inches per foot (mm per m) with a temperature change of 140°F (60°C) is given below.

| Material | in / ft | mm / m |
|-----------------|---------|--------|
| Aluminium Alloy | 0.01728 | 1.44 |
| Copper | 0.01176 | 0.98 |
| Cast Iron | 0.00900 | 0.75 |
| HDPE | 0.10800 | 9.00 |
| PVCu | 0.03600 | 3.00 |
| CPVC | 0.05040 | 4.20 |
| Stainless Steel | 0.01188 | 0.99 |

3 Flow Capacity

ACO Pipe® comes in a wide range of sizes to meet most projects needs, flow tables provided on page 10 provide capacity figures for straight runs. Bends and direction changes significantly impact flow, and are common areas for sediment build up.

Operating Pressure

ACO Pipe® pipes and fittings are equipped with a unique, double seal. This double seal not only provides added security for long term reliability, but also a benefit for ease of installation.

ACO Pipe® is tested and approved for operating pressures in all gravity, syphonic and vacuum systems and is designed for a maximum working pressure between -0.8 bar to 0.5 bar.

In the case where higher pressure may apply, it will be necessary to install the system with socket clamps. [See pages 21 to 23.](#)



Features & Benefits

ACO Pipe® stainless steel pipe systems offer all the key features found in traditional metal rainwater, soil and waste systems but with the additional benefits unique to stainless steel material and the push-fit system.

- Comprehensive range – selection of straights, bends, branches, coupling and installation hardware
- Pipe lengths up to 19'-8" (6 m) for diameters up to 6.3" (160 mm). 9'-10" (3 m) for 7.87" (200 mm) diameter.
- Ease of installation – components are lightweight and push-fit for quick assembly.
- Optimum joint integrity – components have a low coefficient of thermal expansion compared with HDPE (in particular) which tends to fail when operating temperatures vary between 50°F (10°C) and 140°F (60°C).
- Superior seal security – components comprise a unique double lip sealing system, ideal for extraneous conditions.
- Long service life – components manufactured from grade 304 or 316L stainless steel for high corrosion resistance and low on-going maintenance. The expected service life cycle exceeds 50 years.
- Quality design & construction – components exhibit better geometric concentricity, fitting design and weld quality than any other product in the industry.
- Connection adaptability – components are suitable for either push-fit or weld-up connection methods.
- Hygiene - smooth welding surface quality along with pickling and passivation of all stainless steel products within the ACO Pipe® system safeguards against corrosion and allows for easy cleaning.

Reference Standards

ACO Pipe® meets the requirements of ASME A112.3.1 *Stainless Steel Drainage Systems for Sanitary DWV, Storm, And Vacuum Applications, Above and Below Ground.*

ACO Pipe® is designed, manufactured, tested and checked according to the standards EN 1124-1 and EN 1124-2: *Pipes and fittings of longitudinally welded stainless steel pipes with spigot and socket for waste water systems.* Additionally, ACO Pipe® has been assessed and complies to AS3495: *Stainless steel non pressure pipes and fittings.*

Pipe diameters

1.97" (50 mm), 2.95" (75 mm), 4.33" (110 mm), 4.92" (125 mm), 6.30" (160 mm) and 7.87" (200 mm) available as standard.

Contact ACO for details on 1.57" (40 mm), 10" (250 mm) and 12.40" (315 mm) diameter pipe sizes.

Standard sections

Available in 5.91" (150 mm), 9.84" (250 mm), 19.69" (500 mm), 29.53" (750 mm), 39.37" (1000 mm), 59.06" (1500 mm), 78.74" (2000 mm), 98.43" (2500 mm), 118.11" (3000 mm) and 236.22" (6000 mm) lengths for optimum practicality of handling and freight.

Wall thickness

0.04" - 0.06" (1 - 1.5 mm) minimum provides a lightweight, easy to handle system that can withstand everyday wear and tear.

Socketed end profiles

Provide a modular push-fit system, that offers all the time saving benefits of traditional PVC pipe systems.

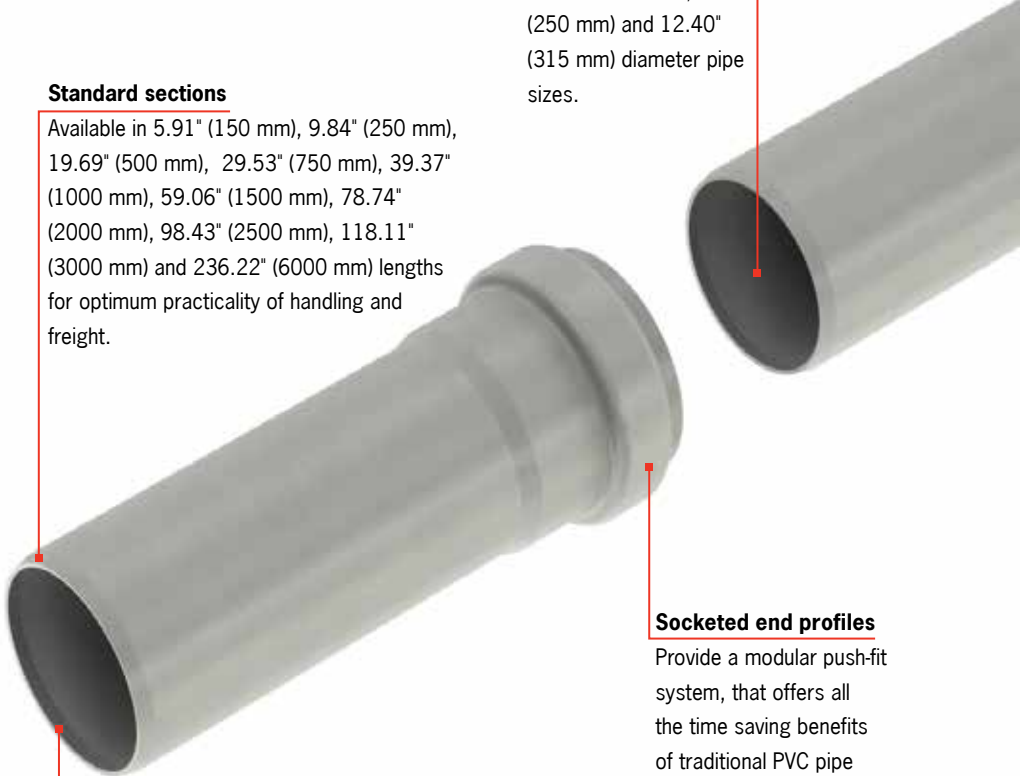

Accessories

A full range of angles, branches, accessories and installation devices reduce the amount of on-site cutting and installation time.



Manufacturing

All components are manufactured using advanced cold-forming techniques which minimize the amount of welding required.



Seal

A unique double lip seal on all joints ensures a trouble-free, reliable system.



Push-fit

A 10° bevel facilitates easy push fit connection of sections. Where required, all joints can be fully circumferentially welded for extra security.

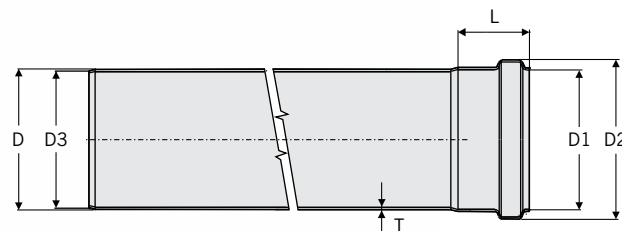

Dimensions of Socket and Spigot

| D in (mm) | D1 in (mm) | D2 in (mm) | D3 in (mm) | Socket Length L in (mm) | Wall Thickness T in (mm) |
|--------------|---------------|---------------|---------------|----------------------------|-----------------------------|
| 1.97 (50) | 2.01 (51) | 2.44 (62) | 1.85 (47) | 1.65 (42) | 0.04 (1.00) |
| 2.95 (75) | 2.99 (76) | 3.44 (88) | 2.83 (72) | 1.97 (50) | 0.04 (1.00) |
| 4.33 (110) | 4.37 (111) | 4.94 (126) | 4.21 (107) | 2.24 (57) | 0.04 (1.00) |
| 4.92 (125) | 4.96 (126) | 5.55 (141) | 4.80 (122) | 2.48 (63) | 0.04 (1.00) |
| 6.30 (160) | 6.34 (161) | 7.01 (178) | 6.14 (156) | 2.76 (70) | 0.05 (1.25) |
| 7.87 (200) | 7.91 (201) | 8.62 (219) | 7.68 (195) | 3.15 (80) | 0.06 (1.50) |



Project Planning – Design Tips

- Perform a risk assessment of installation to assess the consequences of flooding due to blockages of silt and scale build up within pipe system. Repeat this assessment for unexpected hydraulic demands due to accidental spillage, thunderstorms and extraneous events.
- Perform necessary risk assessment if system is likely to be subjected to thermal shock. Within design limits, ACO Pipe® is tolerant of sudden temperature changes without risk of damage.
- Avoid selecting pipe sizes that are at, or close to, their hydraulic capacities, as long-term effects of silt and scale can reduce a system's hydraulic capacity.
- For stormwater applications, check geographical location to confirm design rainfall intensity.
- Confirm actual gradient of installed pipe system. A level (or nearly level) gradient will have a reduced hydraulic performance compared to installations with defined gradients.
- Assess fluids to be drained to avoid corrosion of pipe and/or seals. Checklist as follows:
 - Identify each chemical within the fluid.
 - Establish chemical concentration(s).
 - Confirm maximum temperatures.Given above information, correct seal can be selected. [See pages 20 and 26.](#)
- Design system with minimum number of joints and, where possible, limit number of bends. This will reduce both costs and hydraulic losses.
- Provide good access points for clean-outs to maintain hydraulic performance of system.
- Care should be taken to avoid damage, both during and after installation. Dents and kinks will affect hydraulic performance. For above ground applications, damage will also affect the system's aesthetics.
- The following standards will assist designers in selecting the correct size of pipe system for a particular application.
 - EN 12056: Gravity Drainage Systems Inside Buildings.
 - EN 752: Drain and Sewer Systems Outside Buildings.
 - Refer to [pages 8 and 9](#) for ACO Pipe® hydraulic data.

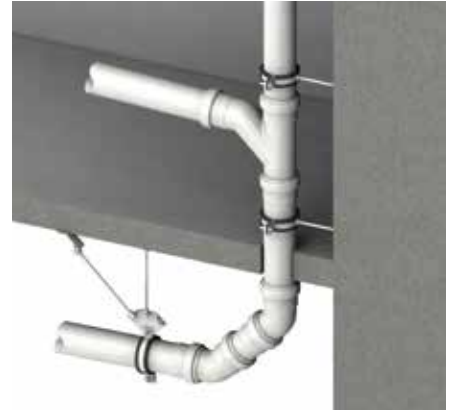

Pipework Support

Installation should be in accordance with the manufacturer's recommendations [See page 21](#), EN12056–2, EN12056–3 and EN752.

Designers must ensure that all pipework is supported with brackets according to the requirements of AS/NZ3500 (see page 25).

Pipe Weights

Engineers should be aware of minimum and maximum weights when designing vertical stack and horizontal pipe run systems. [See page 25.](#)

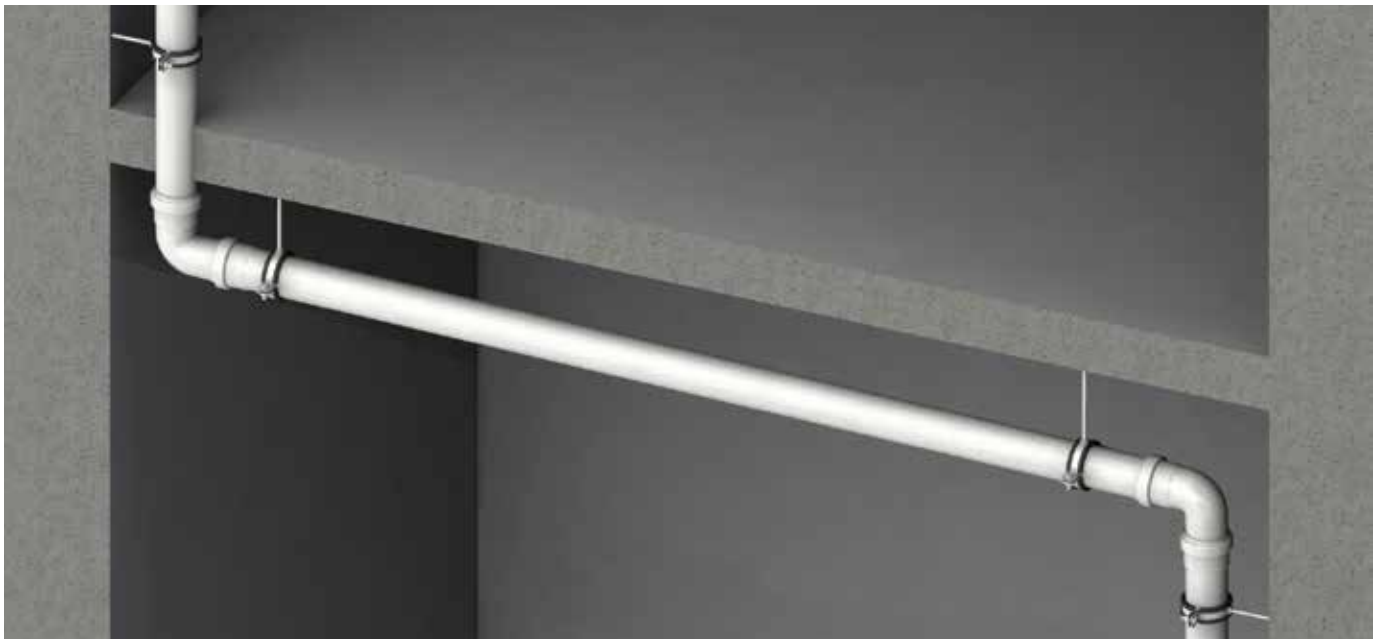

Project Planning – Maintenance Tips



Designing a Maintenance Program

Pipe systems should be cleaned before handing over to the client. More attention than normal may be required if the installation period has been prolonged (blockages, etc.).

During service, food and beverage handling, pharmaceutical and chemical industry applications require extremely high levels of cleanliness applicable to each application.

Frequency of Cleaning Stainless Steel

Generally, it is acceptable to clean the metal when it is dirty to restore original appearance. This may vary from one to four times a year for external applications or it can be daily in hygienic or aggressive environments.

Stainless steel is easy to clean. Washing with soap or mild detergent and warm water, followed by a clear water rinse is usually quite adequate for many industrial applications. An enhanced aesthetic appearance will be achieved if the cleaned surface is wiped dry to remove water spots.

If professional maintenance is required (e.g. for building upgrades), stainless steel can be mechanically cleaned or electropolished by specialists on site.

For more information on care and maintenance [See page 25.](#)

Project Planning – Hydraulic Design

Compared to cast iron, clay and vitreous pipe systems, stainless steel pipes have a considerably smoother bore (Manning Coefficient: 0.011) and in general, are less susceptible to internal scaling.

In some instances, low roughness coefficients (ks) are not generally a true reflection of the long-term hydraulic performance of the installed system. Roughness coefficients of 0.024" (0.6 mm) should be used for rainwater/storm drainage and 0.06" (1.5 mm) for soil/foul drainage.

Flow Tables

Two sets of flow tables are presented for design use.

Table 1 is for pipes installed with level (or nearly level) gradients where the steady, uniform flow equations are not applicable. The data therefore has been generated from ACO's hydraulic design program "Hydro" that is based on the equations of spatially-varied flow.

Table 2 is for pipes installed with varying gradients. The data is based on the Colebrook-White equation using an appropriate roughness coefficient for stainless steel.

When draining storm or foul water, it is inevitable that sediment deposits will occur within the drainage system.

Sediment and scale deposits will reduce flow rate through a pipe system. It is recommended that an allowance is made for this within the design and planning phase.

Table 1. Full bore flow rate tables for level (or nearly level) gradients

Flow rates based on a spatially-varied flow formula for steady non-uniform flow. Manning Coefficient 0.011

| Pipe Ø in (mm) | Length ft (m) | Gradient | | | | | | | |
|-------------------|------------------|----------|---------|-------|---------|-------|---------|-------|---------|
| | | 0.0% | | 0.25% | | 0.5% | | 0.75% | |
| | | Q GPM | Q (l/s) | Q GPM | Q (l/s) | Q GPM | Q (l/s) | Q GPM | Q (l/s) |
| 1.97 (50) | 16.4 (5) | 6 | 0.4 | 9 | 0.6 | 12 | 1 | 15 | 0.9 |
| | 32.8 (10) | 5 | 0.3 | 9 | 0.5 | 12 | 1 | 15 | 0.9 |
| | 49.2 (15) | 4 | 0.3 | 8 | 0.5 | 12 | 1 | 15 | 0.9 |
| | 65.6 (20) | 4 | 0.2 | 8 | 0.5 | 12 | 1 | 15 | 0.9 |
| 2.95 (75) | 16.4 (5) | 23 | 1.5 | 28 | 1.8 | 38 | 2 | 46 | 2.9 |
| | 32.8 (10) | 17 | 1.1 | 27 | 1.7 | 37 | 2 | 46 | 2.9 |
| | 49.2 (15) | 15 | 1.0 | 27 | 1.7 | 37 | 2 | 46 | 2.9 |
| | 65.6 (20) | 13 | 0.9 | 27 | 1.7 | 37 | 2.4 | 46 | 2.9 |
| 4.33 (110) | 16.4 (5) | 71 | 4.5 | 88 | 5.6 | 107 | 6.8 | 129 | 8.2 |
| | 32.8 (10) | 57 | 3.6 | 80 | 5.1 | 105 | 6.6 | 129 | 8.2 |
| | 49.2 (15) | 51 | 3.2 | 78 | 4.9 | 103 | 6.5 | 129 | 8.2 |
| | 65.6 (20) | 44 | 2.8 | 76 | 4.8 | 103 | 6.5 | 129 | 8.2 |
| 4.92 (125) | 16.4 (5) | 102 | 6.5 | 125 | 7.9 | 152 | 9.6 | 181 | 11.5 |
| | 32.8 (10) | 82 | 5.2 | 115 | 7.3 | 151 | 9.5 | 181 | 11.5 |
| | 49.2 (15) | 72 | 4.6 | 111 | 7.0 | 151 | 9.5 | 181 | 11.5 |
| | 65.6 (20) | 65 | 4.1 | 109 | 6.9 | 151 | 9.5 | 181 | 11.5 |
| 6.30 (160) | 16.4 (5) | 206 | 13.0 | 244 | 15.4 | 295 | 18.6 | 336 | 21.2 |
| | 32.8 (10) | 173 | 10.9 | 227 | 14.3 | 293 | 18.5 | 336 | 21.2 |
| | 49.2 (15) | 151 | 9.5 | 219 | 13.8 | 292 | 18.4 | 336 | 21.2 |
| | 65.6 (20) | 135 | 8.5 | 214 | 13.5 | 290 | 18.3 | 336 | 21.2 |
| 7.87 (200) | 16.4 (5) | 393 | 24.8 | 460 | 29.0 | 542 | 34.2 | 613 | 38.7 |
| | 32.8 (10) | 330 | 20.8 | 423 | 26.7 | 536 | 33.8 | 609 | 38.4 |
| | 49.2 (15) | 295 | 18.6 | 407 | 25.7 | 534 | 33.7 | 609 | 38.4 |
| | 65.6 (20) | 269 | 17.0 | 396 | 25.0 | 533 | 33.6 | 609 | 38.4 |

Using spatially varied flow equations, the length to an outlet will determine the maximum flow rate through the pipe. The flow rates shown above assume an unrestricted discharge from the pipe. For installations without an unrestricted discharge, the flow rate will be affected by the downstream throttle.

Table 2 (a-b). Full bore flow rate tables velocities for varying gradients

Table 2a. For rainwater/storm drainage applications

Flow rates based on a Colebrook-White formula. Roughness coefficient ks = 0.024" (0.6 mm)

| Pipe Ø | 1.97" (50 mm) | | | | 2.95" (75 mm) | | | | 4.33" (110 mm) | | | | 4.92" (125 mm) | | | | 6.30" (160 mm) | | | | 7.87" (200 mm) | | | |
|--------|---------------|-------|------|-----|---------------|-------|------|-----|----------------|-------|------|-----|----------------|-------|------|-----|----------------|-------|------|-----|----------------|-------|------|-----|
| | Q | | v | | Q | | v | | Q | | v | | Q | | v | | Q | | v | | Q | | v | |
| | GPM | (l/s) | ft/s | m/s | GPM | (l/s) | ft/s | m/s | GPM | (l/s) | ft/s | m/s | GPM | (l/s) | ft/s | m/s | GPM | (l/s) | ft/s | m/s | GPM | (l/s) | ft/s | m/s |
| 10.0 | 43 | 2.7 | 5.0 | 1.5 | 133 | 8.4 | 6.6 | 2.0 | 377 | 23.8 | 8.5 | 2.6 | 533 | 33.6 | 9.3 | 2.8 | 1,017 | 64.2 | 10.9 | 3.3 | 1,853 | 116.9 | 12.6 | 3.8 |
| 7.5 | 38 | 2.4 | 4.3 | 1.3 | 115 | 7.3 | 5.7 | 1.7 | 327 | 20.6 | 7.4 | 2.3 | 461 | 29.1 | 8.0 | 2.5 | 881 | 55.6 | 9.4 | 2.9 | 1,604 | 101.2 | 10.9 | 3.3 |
| 5.0 | 31 | 1.9 | 3.5 | 1.1 | 94 | 5.9 | 4.7 | 1.4 | 267 | 16.8 | 6.0 | 1.8 | 377 | 23.8 | 6.6 | 2.0 | 719 | 45.4 | 7.7 | 2.3 | 1,310 | 82.7 | 8.9 | 2.7 |
| 4.5 | 29 | 1.8 | 3.3 | 1.0 | 89 | 5.6 | 4.4 | 1.4 | 253 | 16.0 | 5.7 | 1.7 | 357 | 22.6 | 6.2 | 1.9 | 682 | 43.0 | 7.3 | 2.2 | 1,243 | 78.4 | 8.4 | 2.6 |
| 4.0 | 27 | 1.7 | 3.1 | 1.0 | 84 | 5.3 | 4.2 | 1.3 | 239 | 15.1 | 5.4 | 1.6 | 337 | 21.3 | 5.9 | 1.8 | 643 | 40.6 | 6.9 | 2.1 | 1,172 | 73.9 | 8.0 | 2.4 |
| 3.5 | 26 | 1.6 | 3.0 | 0.9 | 79 | 5.0 | 3.9 | 1.2 | 223 | 14.1 | 5.1 | 1.5 | 315 | 19.9 | 5.5 | 1.7 | 602 | 38.0 | 6.4 | 2.0 | 1,096 | 69.1 | 7.4 | 2.3 |
| 3.0 | 24 | 1.5 | 2.7 | 0.8 | 73 | 4.6 | 3.6 | 1.1 | 207 | 13.0 | 4.7 | 1.4 | 292 | 18.4 | 5.1 | 1.6 | 557 | 35.1 | 5.9 | 1.8 | 1,015 | 64.0 | 6.9 | 2.1 |
| 2.5 | 22 | 1.4 | 2.5 | 0.8 | 67 | 4.2 | 3.3 | 1.0 | 189 | 11.9 | 4.3 | 1.3 | 266 | 16.8 | 4.6 | 1.4 | 508 | 32.1 | 5.4 | 1.7 | 926 | 58.4 | 6.3 | 1.9 |
| 2.0 | 19 | 1.2 | 2.2 | 0.7 | 60 | 3.8 | 3.0 | 0.9 | 169 | 10.6 | 3.8 | 1.2 | 238 | 15.0 | 4.1 | 1.3 | 455 | 28.7 | 4.9 | 1.5 | 828 | 52.3 | 5.6 | 1.7 |
| 1.5 | 17 | 1.1 | 1.9 | 0.6 | 52 | 3.3 | 2.6 | 0.8 | 146 | 9.2 | 3.3 | 1.0 | 206 | 13.0 | 3.6 | 1.1 | 394 | 24.8 | 4.2 | 1.3 | 717 | 45.3 | 4.9 | 1.5 |
| 1.0 | 14 | 0.9 | 1.6 | 0.5 | 42 | 2.7 | 2.1 | 0.6 | 119 | 7.5 | 2.7 | 0.8 | 168 | 10.6 | 2.9 | 0.9 | 321 | 20.3 | 3.4 | 1.1 | 586 | 37.0 | 4.0 | 1.2 |

Table 2b. For soil/foul water drainage applications

Flow rates based on a Colebrook-White formula. Roughness coefficient ks = 0.06" (1.5 mm)

| Pipe Ø | 1.97" (50 mm) | | | | 2.95" (75 mm) | | | | 4.33" (110 mm) | | | | 4.92" (125 mm) | | | | 6.30" (160 mm) | | | | 7.87" (200 mm) | | | |
|--------|---------------|-------|------|-----|---------------|-------|------|-----|----------------|-------|------|-----|----------------|-------|------|-----|----------------|-------|------|-----|----------------|-------|------|-----|
| | Q | | v | | Q | | v | | Q | | v | | Q | | v | | Q | | v | | Q | | v | |
| | GPM | (l/s) | ft/s | m/s | GPM | (l/s) | ft/s | m/s | GPM | (l/s) | ft/s | m/s | GPM | (l/s) | ft/s | m/s | GPM | (l/s) | ft/s | m/s | GPM | (l/s) | ft/s | m/s |
| 10.0 | 36 | 2.3 | 4.2 | 1.3 | 113 | 7.1 | 5.6 | 1.7 | 324 | 20.5 | 7.3 | 2.2 | 459 | 29.0 | 8.0 | 2.4 | 881 | 55.6 | 9.4 | 2.9 | 1,614 | 101.8 | 11.0 | 3.3 |
| 7.5 | 32 | 2.0 | 3.6 | 1.1 | 98 | 6.2 | 4.9 | 1.5 | 281 | 17.7 | 6.3 | 1.9 | 398 | 25.1 | 6.9 | 2.1 | 763 | 48.2 | 8.2 | 2.5 | 1,398 | 88.2 | 9.5 | 2.9 |
| 5.0 | 25 | 1.6 | 2.6 | 0.8 | 72 | 4.5 | 3.5 | 1.1 | 205 | 12.9 | 4.6 | 1.4 | 290 | 18.3 | 5.1 | 1.5 | 557 | 35.2 | 6.0 | 1.8 | 1,021 | 64.4 | 6.9 | 2.1 |
| 3.5 | 22 | 1.4 | 2.5 | 0.8 | 67 | 4.2 | 3.3 | 1.0 | 192 | 12.1 | 4.3 | 1.3 | 272 | 17.1 | 4.7 | 1.4 | 521 | 32.9 | 5.6 | 1.7 | 955 | 60.2 | 6.5 | 2.0 |
| 3.0 | 20 | 1.3 | 2.3 | 0.7 | 62 | 3.9 | 3.1 | 0.9 | 178 | 11.2 | 4.0 | 1.2 | 252 | 15.9 | 4.4 | 1.3 | 483 | 30.5 | 5.2 | 1.6 | 884 | 55.8 | 6.0 | 1.8 |
| 2.5 | 18 | 1.2 | 2.1 | 0.6 | 57 | 3.6 | 2.8 | 0.9 | 162 | 10.2 | 3.7 | 1.1 | 230 | 14.5 | 4.0 | 1.2 | 441 | 27.8 | 4.7 | 1.4 | 807 | 50.9 | 5.5 | 1.7 |
| 2.0 | 16 | 1.0 | 1.9 | 0.6 | 51 | 3.2 | 2.5 | 0.8 | 145 | 9.2 | 3.3 | 1.0 | 205 | 13.0 | 3.6 | 1.1 | 394 | 24.9 | 4.2 | 1.3 | 722 | 45.5 | 4.9 | 1.5 |
| 1.5 | 14 | 0.9 | 1.6 | 0.5 | 44 | 2.8 | 2.2 | 0.7 | 126 | 7.9 | 2.8 | 0.9 | 178 | 11.2 | 3.1 | 0.9 | 341 | 21.5 | 3.6 | 1.1 | 625 | 39.4 | 4.2 | 1.3 |
| 1.0 | 12 | 0.7 | 1.3 | 0.4 | 36 | 2.3 | 1.8 | 0.5 | 103 | 6.5 | 2.3 | 0.7 | 145 | 9.2 | 2.5 | 0.8 | 279 | 17.6 | 3.0 | 0.9 | 510 | 32.2 | 3.5 | 1.1 |

The flow rates shown above assume an unrestricted discharge from the pipe. For installations without an unrestricted discharge, the flow rate will be affected by the downstream throttle. For shallow gradients, the Colebrook-White formula underestimates flow rates (because when gradient tends towards zero%, velocity also tends to zero). For level (or nearly level) installations (slope < 1%), spatially varied flow tables should be used; refer to Table 1.

Parts Tables - Straights

Socketed Pipes 1.97" (50 mm)

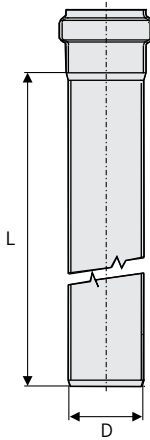

| D in (mm) | Active Length - L in (mm) | Weight lbs | Part No AISI 304 | Part No AISI 316L |
|--------------|------------------------------|---------------|---------------------|----------------------|
| 1.97 (50) | 5.91 (150) | 0.4 | 98500 | 98550 |
| 1.97 (50) | 9.84 (250) | 0.9 | 98502 | 98552 |
| 1.97 (50) | 19.69 (500) | 1.5 | 98504 | 98554 |
| 1.97 (50) | 29.53 (750) | 2.2 | 98506 | 98556 |
| 1.97 (50) | 39.37 (1000) | 2.9 | 98508 | 98558 |
| 1.97 (50) | 59.06 (1500) | 4.2 | 98510 | 98560 |
| 1.97 (50) | 78.74 (2000) | 5.7 | 98512 | 98562 |
| 1.97 (50) | 98.43 (2500) | 7.0 | 419274 | 419282 |
| 1.97 (50) | 118.11 (3000) | 8.4 | 98514 | 98564 |
| 1.97 (50) | 157.48 (4000) | 11.0 | 419458 | 419482 |
| 1.97 (50) | 196.85 (5000) | 13.9 | 419466 | 419490 |
| 1.97 (50) | 236.22 (6000) | 16.5 | 419474 | 419498 |

Socketed Pipes 2.95" (75 mm)

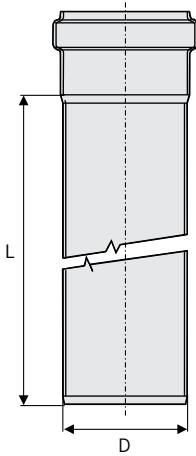

| D in (mm) | Active Length - L in (mm) | Weight lbs | Part No AISI 304 | Part No AISI 316L |
|--------------|------------------------------|---------------|---------------------|----------------------|
| 2.95 (75) | 5.91 (150) | 0.9 | 98516 | 98566 |
| 2.95 (75) | 9.84 (250) | 1.3 | 98518 | 98568 |
| 2.95 (75) | 19.69 (500) | 2.2 | 98520 | 98570 |
| 2.95 (75) | 29.53 (750) | 3.3 | 98522 | 98572 |
| 2.95 (75) | 39.37 (1000) | 4.4 | 98524 | 98574 |
| 2.95 (75) | 59.06 (1500) | 6.4 | 98526 | 98576 |
| 2.95 (75) | 78.74 (2000) | 7.9 | 98528 | 98578 |
| 2.95 (75) | 98.43 (2500) | 10.6 | 419276 | 419284 |
| 2.95 (75) | 118.11 (3000) | 12.5 | 98530 | 98580 |
| 2.95 (75) | 157.48 (4000) | 16.7 | 419460 | 419484 |
| 2.95 (75) | 196.85 (5000) | 20.7 | 419468 | 419492 |
| 2.95 (75) | 236.22 (6000) | 24.9 | 419476 | 419500 |

Socketed Pipes 4.33" (110 mm)

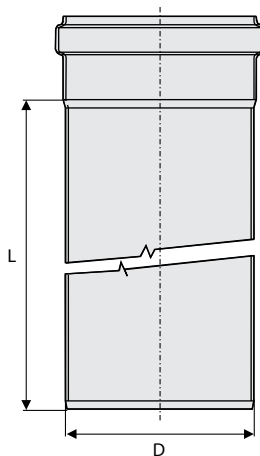

| D in (mm) | Active Length - L in (mm) | Weight lbs | Part No AISI 304 | Part No AISI 316L |
|--------------|------------------------------|---------------|---------------------|----------------------|
| 4.33 (110) | 5.91 (150) | 1.3 | 98532 | 98582 |
| 4.33 (110) | 9.84 (250) | 2.0 | 98534 | 98584 |
| 4.33 (110) | 19.69 (500) | 3.3 | 98536 | 98586 |
| 4.33 (110) | 29.53 (750) | 4.8 | 98538 | 98588 |
| 4.33 (110) | 39.37 (1000) | 6.4 | 98540 | 98590 |
| 4.33 (110) | 59.06 (1500) | 9.5 | 98542 | 98592 |
| 4.33 (110) | 78.74 (2000) | 12.5 | 98544 | 98594 |
| 4.33 (110) | 98.43 (2500) | 15.6 | 419278 | 419286 |
| 4.33 (110) | 118.11 (3000) | 18.5 | 98546 | 98596 |
| 4.33 (110) | 157.48 (4000) | 24.4 | 419462 | 419486 |
| 4.33 (110) | 196.85 (5000) | 30.6 | 419470 | 419494 |
| 4.33 (110) | 236.22 (6000) | 36.7 | 419478 | 419502 |

EPDM seals are supplied as standard.

For more aggressive applications, FPM & NBR seals are available. Contact ACO.

Parts Tables - Straights

Socketed Pipes 4.92" (125 mm)

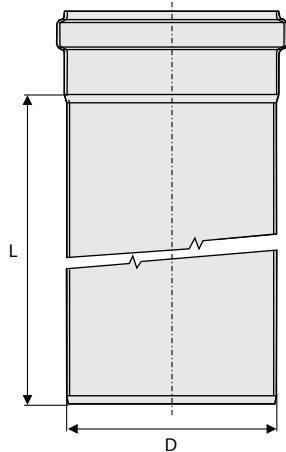

| D in (mm) | Active Length - L in (mm) | Weight lbs | Part No AISI 304 | Part No AISI 316L |
|--------------|------------------------------|---------------|---------------------|----------------------|
| 4.92 (125) | 5.91 (150) | 1.5 | 419692 | 419712 |
| 4.92 (125) | 9.84 (250) | 2.2 | 419694 | 419714 |
| 4.92 (125) | 19.69 (500) | 3.8 | 419696 | 419716 |
| 4.92 (125) | 29.53 (750) | 5.5 | 419698 | 419718 |
| 4.92 (125) | 39.37 (1000) | 7.3 | 419700 | 419720 |
| 4.92 (125) | 59.06 (1500) | 10.8 | 419702 | 419722 |
| 4.92 (125) | 78.74 (2000) | 14.3 | 419704 | 419724 |
| 4.92 (125) | 98.43 (2500) | 17.8 | 419708 | 419728 |
| 4.92 (125) | 118.11 (3000) | 21.1 | 419706 | 419726 |
| 4.92 (125) | 236.22 (6000) | 41.9 | 419710 | 419730 |

Socketed Pipes 6.30" (160 mm)

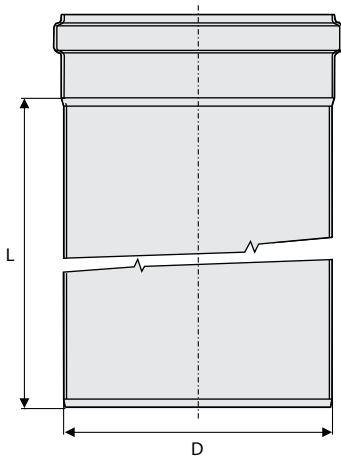

| D in (mm) | Active Length - L in (mm) | Weight lbs | Part No AISI 304 | Part No AISI 316L |
|--------------|------------------------------|---------------|---------------------|----------------------|
| 6.30 (160) | 5.91 (150) | 2.4 | 98548 | 98598 |
| 6.30 (160) | 9.84 (250) | 3.5 | 98600 | 98650 |
| 6.30 (160) | 19.69 (500) | 6.4 | 98602 | 98652 |
| 6.30 (160) | 29.53 (750) | 9.0 | 98604 | 98654 |
| 6.30 (160) | 39.37 (1000) | 11.9 | 98606 | 98656 |
| 6.30 (160) | 59.06 (1500) | 17.4 | 98608 | 98658 |
| 6.30 (160) | 78.74 (2000) | 22.9 | 98610 | 98660 |
| 6.30 (160) | 98.43 (2500) | 28.4 | 419280 | 419288 |
| 6.30 (160) | 118.11 (3000) | 33.9 | 98612 | 98662 |
| 6.30 (160) | 157.48 (4000) | 44.4 | 419464 | 419488 |
| 6.30 (160) | 196.85 (5000) | 55.9 | 419472 | 419496 |
| 6.30 (160) | 236.22 (6000) | 66.9 | 419480 | 419504 |

Socketed Pipes 7.87" (200 mm)

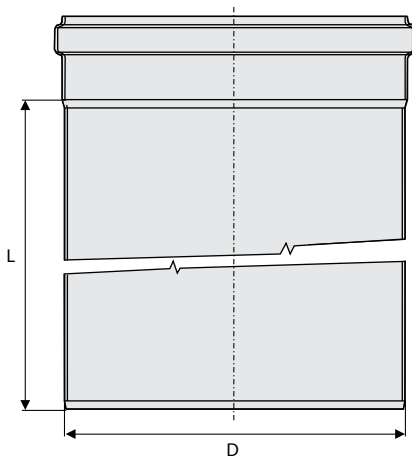

| D in (mm) | Active Length - L in (mm) | Weight lbs | Part No AISI 304 | Part No AISI 316L |
|--------------|------------------------------|---------------|---------------------|----------------------|
| 7.87 (200) | 19.69 (500) | 9.9 | 419383 | 419384 |
| 7.87 (200) | 39.37 (1000) | 18.3 | 419387 | 419388 |
| 7.87 (200) | 78.74 (2000) | 34.8 | 419391 | 419392 |
| 7.87 (200) | 118.11 (3000) | 51.0 | 419395 | 419396 |

EPDM seals are supplied as standard.
For more aggressive applications, FPM & NBR seals are available. Contact ACO.

Parts Tables - Bends

Bends 87.5°

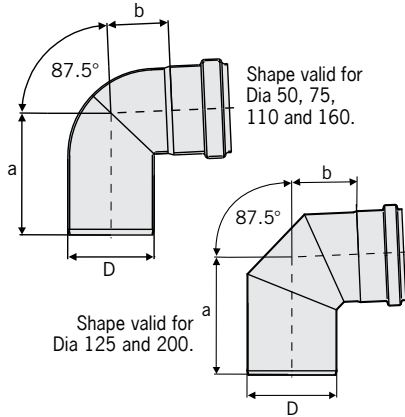

| D in (mm) | a in (mm) | b in (mm) | Weight lbs | Part No AISI 304 | Part No AISI 316L |
|--------------|--------------|--------------|---------------|---------------------|----------------------|
| 1.97 (50) | 3.4 (86) | 1.6 (40) | 40.4 | 98700 | 98750 |
| 2.95 (75) | 4.2 (107) | 2.1 (53) | 80.8 | 98702 | 98752 |
| 4.33 (110) | 5.3 (134) | 2.6 (67) | 141.4 | 98704 | 98754 |
| 4.92 (125) | 6.3 (161) | 3.7 (93) | 161.6 | 419732 | 419734 |
| 6.30 (160) | 7.1 (181) | 4.1 (105) | 343.4 | 98706 | 98756 |
| 7.87 (200) | 8.5 (215) | 5.1 (129) | 787.8 | 419411 | 419413 |

Bends 45°

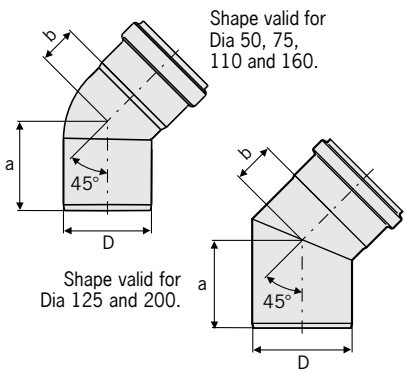

| D in (mm) | a in (mm) | b in (mm) | Weight lbs | Part No AISI 304 | Part No AISI 316L |
|--------------|--------------|--------------|---------------|---------------------|----------------------|
| 1.97 (50) | 2.4 (62) | 0.9 (24) | 40.4 | 98708 | 98758 |
| 2.95 (75) | 3.0 (76) | 1.3 (32) | 60.6 | 98710 | 98760 |
| 4.33 (110) | 3.7 (93) | 1.7 (42) | 101.0 | 98712 | 98762 |
| 4.92 (125) | 4.3 (110) | 2.0 (50) | 115.1 | 419736 | 419738 |
| 6.30 (160) | 5.2 (131) | 2.2 (55) | 262.6 | 98714 | 98764 |
| 7.87 (200) | 6.0 (152) | 2.4 (60) | 545.4 | 419407 | 419409 |

Bends 30°

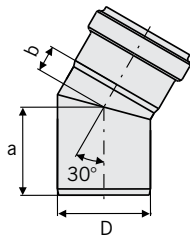

| D in (mm) | a in (mm) | b in (mm) | Weight lbs | Part No AISI 304 | Part No AISI 316L |
|--------------|--------------|--------------|---------------|---------------------|----------------------|
| 1.97 (50) | 2.2 (57) | 0.6 (16) | 40.4 | 98716 | 98766 |
| 2.95 (75) | 2.8 (71) | 0.8 (21) | 60.6 | 98718 | 98768 |
| 4.33 (110) | 3.3 (85) | 1.1 (27) | 101.0 | 98720 | 98770 |
| 4.92 (125) | 3.9 (98) | 1.1 (28) | 115.1 | 419740 | 419742 |
| 6.30 (160) | 4.3 (110) | 1.6 (40) | 242.4 | 98722 | 98772 |
| 7.87 (200) | 5.4 (137) | 1.8 (45) | 464.6 | 419403 | 419405 |

Bends 15°

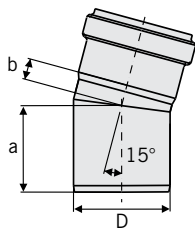

| D in (mm) | a in (mm) | b in (mm) | Weight lbs | Part No AISI 304 | Part No AISI 316L |
|--------------|--------------|--------------|---------------|---------------------|----------------------|
| 1.97 (50) | 2.1 (54) | 0.5 (12) | 20.2 | 98724 | 98774 |
| 2.95 (75) | 2.6 (66) | 0.6 (16) | 60.6 | 98726 | 98776 |
| 4.33 (110) | 3.1 (78) | 0.6 (15) | 80.8 | 98728 | 98778 |
| 4.92 (125) | 3.3 (84) | 0.7 (19) | 90.9 | 419744 | 419746 |
| 6.30 (160) | 3.9 (99) | 1.1 (29) | 202.0 | 98730 | 98780 |
| 7.87 (200) | 4.8 (123) | 1.2 (31) | 383.8 | 419399 | 419401 |

EPDM seals are supplied as standard.
For more aggressive applications, FPM & NBR seals are available. Contact ACO.

Parts Tables - Branches

Single Branches 87.5°

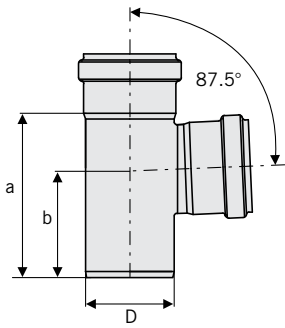

| D in (mm) | a in (mm) | b in (mm) | Weight lbs | Part No AISI 304 | Part No AISI 316L |
|--------------|--------------|--------------|---------------|---------------------|----------------------|
| 1.97 (50) | 3.4 (86) | 1.6 (40) | 0.7 | 98732 | 98782 |
| 2.95 (75) | 4.2 (107) | 2.1 (53) | 1.1 | 98734 | 98784 |
| 4.33 (110) | 5.3 (134) | 2.6 (67) | 1.8 | 98736 | 98786 |
| 4.92 (125) | 6.3 (161) | 3.7 (93) | 2.0 | 419748 | 419750 |
| 6.30 (160) | 7.1 (181) | 4.1 (105) | 5.1 | 98738 | 98788 |
| 7.87 (200) | 8.5 (215) | 5.1 (129) | 9.9 | 419419 | 419421 |

Single Reduction Branches 87.5°

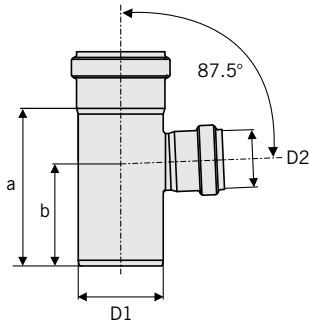

| D1 in (mm) | D2 in (mm) | a in (mm) | b in (mm) | Weight lbs | Part No AISI 304 | Part No AISI 316L |
|---------------|---------------|--------------|--------------|---------------|---------------------|----------------------|
| 2.95 (75) | 1.97 (50) | 5.5 (139) | 3.5 (90) | 0.7 | 98928 | 98930 |
| 4.33 (110) | 1.97 (50) | 7.2 (183) | 4.6 (117) | 1.1 | 98932 | 98934 |
| 4.33 (110) | 2.95 (75) | 7.2 (183) | 4.6 (117) | 1.8 | 98936 | 98938 |
| 4.92 (125) | 2.95 (75) | 7.4 (187) | 4.3 (110) | 2.0 | 419752 | 419754 |
| 4.92 (125) | 4.33 (110) | 8.1 (206) | 5.0 (127) | 2.0 | 419756 | 419758 |
| 6.30 (160) | 4.33 (110) | 11.3 (288) | 7.2 (184) | 5.1 | 400691 | 400693 |
| 7.87 (200) | 6.30 (160) | 11.5 (293) | 7.3 (186) | 8.1 | 419415 | 419417 |

Double Reduction Branches 87.5°

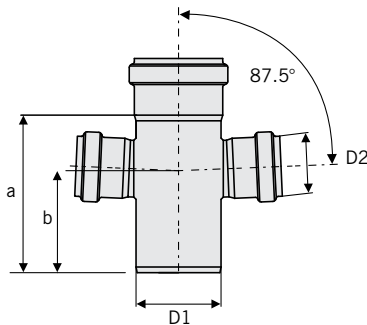

| D1 in (mm) | D2 in (mm) | a in (mm) | b in (mm) | Weight lbs | Part No AISI 304 | Part No AISI 316L |
|---------------|---------------|--------------|--------------|---------------|---------------------|----------------------|
| 2.95 (75) | 1.97 (50) | 5.5 (139) | 3.5 (90) | 0.7 | 98940 | 98942 |
| 4.33 (110) | 1.97 (50) | 7.2 (183) | 4.6 (117) | 1.3 | 98944 | 98946 |
| 4.33 (110) | 2.95 (75) | 7.2 (183) | 4.6 (117) | 2.0 | 98900 | 98902 |
| 6.30 (160) | 4.33 (110) | 11.3 (288) | 7.2 (184) | 5.9 | 400695 | 400697 |

Swept Single Branches 87.5°

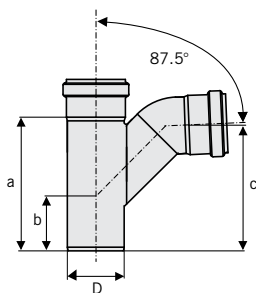

| D in (mm) | a in (mm) | b in (mm) | c in (mm) | Weight lbs | Part No AISI 304 | Part No AISI 316L |
|--------------|--------------|--------------|--------------|---------------|---------------------|----------------------|
| 1.97 (50) | 5.0 (128) | 2.2 (57) | 4.6 (117) | 0.7 | 98814 | 98864 |
| 2.95 (75) | 7.0 (179) | 2.9 (74) | 6.2 (157) | 1.3 | 98816 | 98866 |
| 4.33 (110) | 9.2 (233) | 3.5 (88) | 8.2 (209) | 2.4 | 98818 | 98868 |
| 6.30 (160) | 13.1 (332) | 7.2 (184) | 11.9 (302) | 6.2 | 98820 | 98870 |

EPDM seals are supplied as standard.
For more aggressive applications, FPM & NBR seals are available. Contact ACO.

Parts Tables - Branches

Single Branches 45°

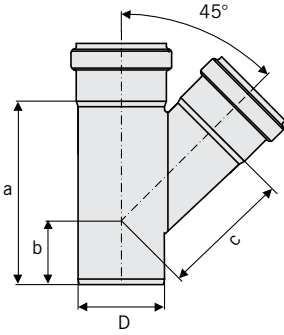

| D in (mm) | a in (mm) | b in (mm) | c in (mm) | Weight lbs | Part No AISI 304 | Part No AISI 316L |
|--------------|--------------|--------------|--------------|---------------|---------------------|----------------------|
| 1.97 (50) | 5.0 (128) | 2.2 (57) | 3.0 (76) | 0.7 | 98748 | 98798 |
| 2.95 (75) | 7.0 (179) | 2.9 (74) | 4.3 (110) | 1.1 | 98800 | 98850 |
| 4.33 (110) | 9.2 (233) | 3.5 (88) | 5.9 (149) | 2.2 | 98802 | 98852 |
| 4.92 (125) | 10.7 (273) | 4.1 (103) | 6.7 (170) | 2.5 | 419760 | 419762 |
| 6.30 (160) | 13.1 (332) | 4.7 (119) | 8.7 (222) | 5.7 | 98804 | 98854 |
| 7.87 (200) | 16.3 (415) | 5.9 (151) | 10.8 (274) | 12.5 | 419427 | 419429 |

Double Branches 45°

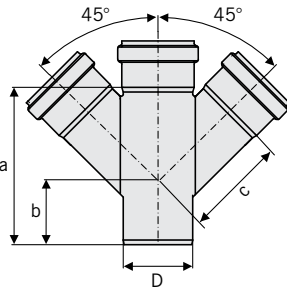

| D in (mm) | a in (mm) | b in (mm) | c in (mm) | Weight lbs | Part No AISI 304 | Part No AISI 316L |
|--------------|--------------|--------------|--------------|---------------|---------------------|----------------------|
| 1.97 (50) | 5.0 (128) | 2.2 (57) | 3.0 (76) | 0.9 | 98806 | 98856 |
| 2.95 (75) | 7.0 (179) | 2.9 (74) | 4.3 (110) | 1.5 | 98808 | 98858 |
| 4.33 (110) | 9.2 (233) | 3.5 (88) | 5.9 (149) | 2.6 | 98810 | 98860 |
| 6.30 (160) | 13.1 (332) | 7.2 (184) | 8.7 (222) | 7.7 | 98812 | 98862 |

Single Reduction Branches 45°

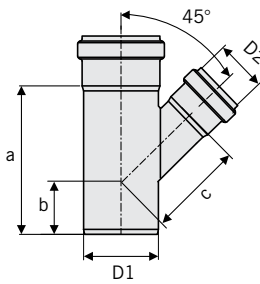

| D1 in (mm) | D2 in (mm) | a in (mm) | b in (mm) | c in (mm) | Weight lbs | Part No AISI 304 | Part No AISI 316L |
|---------------|---------------|--------------|--------------|--------------|---------------|---------------------|----------------------|
| 2.95 (75) | 1.97 (50) | 5.7 (144) | 2.2 (56) | 3.7 (94) | 0.7 | 400661 | 400663 |
| 4.33 (110) | 1.97 (50) | 5.8 (147) | 1.7 (42) | 4.7 (119) | 1.1 | 400665 | 400667 |
| 4.33 (110) | 2.95 (75) | 7.2 (182) | 2.4 (60) | 5.3 (135) | 2.2 | 400669 | 400671 |
| 4.92 (125) | 2.95 (75) | 7.9 (200) | 2.6 (65) | 5.6 (141) | 2.5 | 419764 | 419766 |
| 4.92 (125) | 4.33 (110) | 9.8 (250) | 3.5 (90) | 6.3 (160) | 2.5 | 419768 | 419770 |
| 6.30 (160) | 4.33 (110) | 13.1 (332) | 4.7 (119) | 7.5 (191) | 5.7 | 400699 | 400701 |
| 7.87 (200) | 6.30 (160) | 14.1 (359) | 4.8 (123) | 9.8 (250) | 10.3 | 419423 | 419425 |

Double Reduction Branches 45°

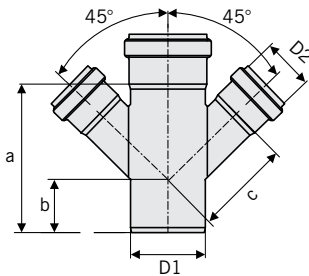

| D1 in (mm) | D2 in (mm) | a in (mm) | b in (mm) | c in (mm) | Weight lbs | Part No AISI 304 | Part No AISI 316L |
|---------------|---------------|--------------|--------------|--------------|---------------|---------------------|----------------------|
| 2.95 (75) | 1.97 (50) | 5.7 (144) | 2.2 (56) | 3.7 (94) | 0.9 | 400673 | 400675 |
| 4.33 (110) | 1.97 (50) | 5.8 (147) | 1.7 (42) | 4.7 (119) | 1.5 | 400677 | 400679 |
| 4.33 (110) | 2.95 (75) | 7.2 (182) | 2.4 (60) | 5.3 (135) | 2.6 | 400681 | 400683 |
| 6.30 (160) | 4.33 (110) | 13.1 (332) | 4.7 (119) | 7.5 (190) | 7.7 | 400703 | 400705 |

'P' Traps

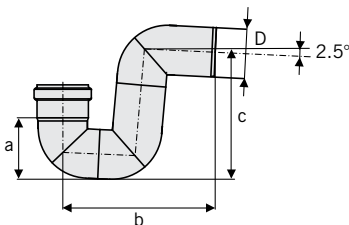

| D in (mm) | a in (mm) | b in (mm) | c in (mm) | Weight lbs | Part No AISI 304 | Part No AISI 316L |
|--------------|--------------|--------------|--------------|---------------|---------------------|----------------------|
| 1.97 (50) | 2.7 (68) | 7.4 (187) | 5.9 (149) | 1.1 | 98822 | 98872 |
| 2.95 (75) | 3.7 (94) | 9.1 (232) | 7.6 (193) | 1.5 | 98824 | 98874 |
| 4.33 (110) | 5.2 (132) | 11.8 (300) | 10.0 (254) | 2.9 | 98826 | 98876 |
| 6.30 (160) | 7.5 (190) | 15.9 (404) | 13.7 (347) | 7.3 | 98828 | 98878 |

EPDM seals are supplied as standard.
For more aggressive applications, FPM & NBR seals are available. Contact ACO.

Parts Tables - Coupling/Socket

Straight Couplings

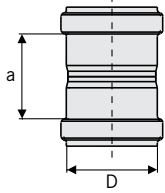

Straight couplings are used to connect two male end pipe sections

| D in (mm) | a in (mm) | Weight lbs | Part No AISI 304 | Part No AISI 316L |
|--------------|--------------|---------------|---------------------|----------------------|
| 1.97 (50) | 2.1 (54) | 0.2 | 98920 | 98970 |
| 2.95 (75) | 3.0 (75) | 0.4 | 98922 | 98972 |
| 4.33 (110) | 3.3 (84) | 0.9 | 98924 | 98974 |
| 4.92 (125) | 5.5 (140) | 0.9 | 419813 | 419815 |
| 6.30 (160) | 4.3 (110) | 1.8 | 98926 | 98976 |
| 7.87 (200) | 5.4 (136) | 4.0 | 419431 | 419433 |

Repair Couplings

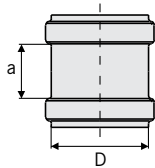

Repair couplings are used to aid a convenient repair to a damaged in-situ pipe. Unlike the standard straight coupling, there is no central registration to limit the insertion depth of the pipe. The repair coupling slides completely over a pipe joint and simply re-positioned to bridge the required pipe joint.
Installation tip: mark the final position of the repair coupling on the installed pipe system to ensure the coupling seals are positioned symmetrically about the pipe joint.

| D in (mm) | a in (mm) | Weight lbs | Part No AISI 304 | Part No AISI 316L |
|--------------|--------------|---------------|---------------------|----------------------|
| 1.97 (50) | 1.7 (44) | 0.2 | 98830 | 98880 |
| 2.95 (75) | 1.8 (46) | 0.4 | 98832 | 98882 |
| 4.33 (110) | 2.0 (52) | 0.7 | 98834 | 98884 |
| 4.92 (125) | 2.8 (70) | 0.7 | 419772 | 419774 |
| 6.30 (160) | 3.0 (76) | 1.5 | 98836 | 98886 |
| 7.87 (200) | 3.9 (100) | 3.3 | 419435 | 419437 |

Expansion Sockets

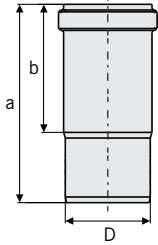

| D in (mm) | a in (mm) | b in (mm) | Weight lbs | Part No AISI 304 | Part No AISI 316L |
|--------------|--------------|--------------|---------------|---------------------|----------------------|
| 1.97 (50) | 6.3 (159) | 4.0 (102) | 0.4 | 98664 | 98666 |
| 2.95 (75) | 6.9 (175) | 4.4 (113) | 0.7 | 98668 | 98670 |
| 4.33 (110) | 7.9 (200) | 4.8 (121) | 1.1 | 98672 | 98674 |
| 4.92 (125) | 9.8 (250) | 6.5 (165) | 1.3 | 419776 | 419778 |
| 6.30 (160) | 11.5 (292) | 6.7 (170) | 3.1 | 98676 | 98678 |

Expansion sockets are used in applications with excessive thermal movement.

Socket Plugs

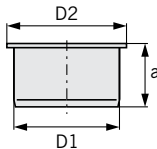

| D1 in (mm) | D2 in (mm) | a in (mm) | Weight lbs | Part No AISI 304 | Part No AISI 316L |
|---------------|---------------|--------------|---------------|---------------------|----------------------|
| 1.97 (50) | 2.3 (58) | 1.8 (45) | 0.2 | - | 98888 |
| 2.95 (75) | 3.4 (85) | 1.8 (45) | 0.7 | - | 98889 |
| 4.33 (110) | 4.7 (120) | 1.8 (45) | 1.1 | - | 98890 |
| 4.92 (125) | 5.3 (135) | 2.0 (50) | 1.3 | - | 419782 |
| 6.30 (160) | 6.7 (170) | 2.0 (50) | 1.1 | - | 98891 |
| 7.87 (200) | 8.3 (210) | 2.0 (50) | 2.2 | - | 98994 |

Socket Plugs with Clamp

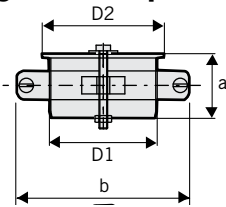

| D1 in (mm) | D2 in (mm) | a in (mm) | b in (mm) | Weight lbs | Part No AISI 304 | Part No AISI 316L |
|---------------|---------------|--------------|--------------|---------------|---------------------|----------------------|
| 1.97 (50) | 2.3 (58) | 1.8 (45) | 3.5 (88) | 0.9 | - | 419138 |
| 2.95 (75) | 3.4 (85) | 1.8 (45) | 4.7 (120) | 1.5 | - | 419139 |
| 4.33 (110) | 4.7 (120) | 1.8 (45) | 6.6 (167) | 2.4 | - | 419140 |
| 6.30 (160) | 6.7 (170) | 2.0 (50) | 8.4 (214) | 2.4 | - | 419141 |

Eccentric and Concentric Inserter Couplings

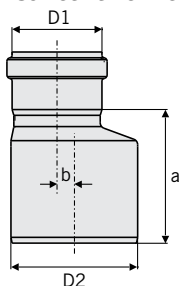

| D1 in (mm) | D2 in (mm) | a in (mm) | b in (mm) | Weight lbs | Part No AISI 304 | Part No AISI 316L |
|---------------|---------------|--------------|--------------|---------------|---------------------|----------------------|
| 1.97 (50) | 2.95 (75) | 3.5 (88) | 0.3 (7) | 0.3 | - | 98892 |
| 1.97 (50) | 4.33 (110) | 4.1 (103) | 1.0 (25) | 0.4 | - | 98878 |
| 2.95 (75) | 4.33 (110) | 4.6 (116) | 0.6 (15) | 0.5 | - | 98894 |
| 4.33 (110) | 4.92 (125) | 4.2 (107) | 0† | 0.6 | - | 419780 |
| 4.33 (110) | 6.30 (160) | 4.8 (123) | 0.9 (22) | 1.1 | - | 98896 |
| 4.92 (125) | 6.30 (160) | 5.9 (150) | 0† | 1.2 | - | 419811 |
| 6.30 (160) | 7.87 (200) | 6.7 (170) | 0† | 1.8 | - | 419441 |

† These couplings are designed as concentric.

EPDM seals are supplied as standard.
For more aggressive applications, FPM & NBR seals are available. Contact ACO.

Parts Tables - Connectors

Connectors with Internal Screw Thread and Spigot

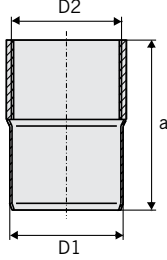

| D1 in (mm) | D2 | a in (mm) | Weight lbs | Part No AISI 304 | Part No AISI 316L |
|---------------|----------------------------------|--------------|---------------|---------------------|----------------------|
| 1.97 (50) | Rp 1 ¹ / ₄ | 2.8 (72) | 0.4 | - | 98956 |
| 1.97 (50) | Rp 1 ¹ / ₂ | 3.0 (75) | 0.6 | - | 98957 |
| 1.97 (50) | Rp 2 | 3.1 (80) | 0.7 | - | 98958 |

Connectors with External Screw Thread and Spigot

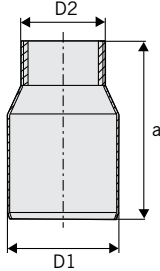

| D1 in (mm) | D2 | a in (mm) | Weight lbs | Part No AISI 304 | Part No AISI 316L |
|---------------|----------------------------------|--------------|---------------|---------------------|----------------------|
| 1.97 (50) | Rp 1 ¹ / ₄ | 3.9 (100) | 0.4 | - | 419330 |
| 1.97 (50) | Rp 1 ¹ / ₂ | 3.9 (100) | 0.6 | - | 419331 |
| 1.97 (50) | Rp 2 | 3.9 (100) | 0.7 | - | 419332 |

Connectors with Socket and External Screw Thread

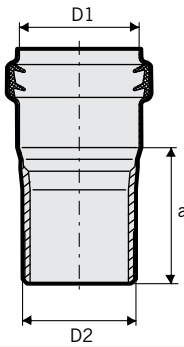

| D1 in (mm) | D2 | a in (mm) | Weight lbs | Part No AISI 304 | Part No AISI 316L |
|---------------|----------------------------------|--------------|---------------|---------------------|----------------------|
| 1.97 (50) | Rp 1 ¹ / ₄ | 2.3 (58) | 0.4 | - | 419250 |
| 1.97 (50) | Rp 1 ¹ / ₂ | 2.3 (58) | 0.6 | - | 419252 |
| 1.97 (50) | Rp 2 | 2.3 (58) | 0.7 | - | 419254 |

Connectors with Socket and Internal Screw Thread

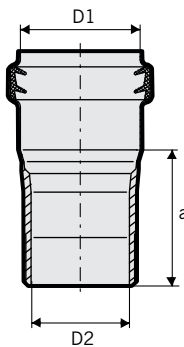

| D1 in (mm) | D2 | a in (mm) | Weight lbs | Part No AISI 304 | Part No AISI 316L |
|---------------|----------------------------------|--------------|---------------|---------------------|----------------------|
| 1.97 (50) | Rp 1 ¹ / ₄ | 2.3 (58) | 0.4 | - | 419333 |
| 1.97 (50) | Rp 1 ¹ / ₂ | 2.3 (58) | 0.6 | - | 419335 |
| 1.97 (50) | Rp 2 | 2.3 (58) | 0.7 | - | 419337 |

Connectors with Socket and Flange

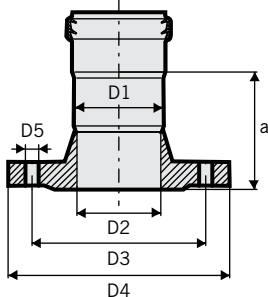

| D1 in (mm) | D2 in (mm) | D3 in (mm) | D4 in (mm) | n x D5 | a in (mm) | Weight lbs | Part No AISI 304 | Part No AISI 316L |
|---------------|---------------|---------------|---------------|---------|--------------|---------------|---------------------|----------------------|
| 1.97 (50) | 1.57 (40) | 4.3 (110) | 5.9 (150) | 4 x 18 | 3.9 (100) | 5.1 | - | 419256 |
| 1.97 (50) | 1.97 (50) | 4.9 (125) | 6.5 (165) | 4 x 18 | 3.9 (100) | 5.9 | - | 419258 |
| 2.95 (75) | 2.56 (65) | 5.7 (145) | 7.3 (185) | 4 x 18 | 3.9 (100) | 7.5 | - | 419260 |
| 4.33 (110) | 3.94 (100) | 7.1 (180) | 8.7 (220) | 8 x 18 | 3.9 (100) | 10.8 | - | 419262 |
| 7.87 (200) | 7.87 (200) | 11.6 (295) | 13.4 (340) | 12 x 22 | 4.2 (102) | 26.4 | - | 419514 |

Note: Further flange information available on request.

EPDM seals are supplied as standard.
For more aggressive applications, FPM & NBR seals are available. Contact ACO.

Parts Tables - Accessories

Connectors with Socket and Flange

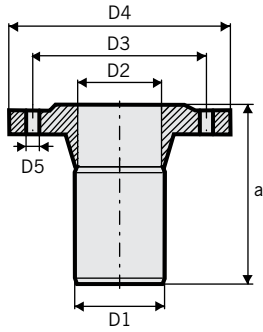

| D1 in (mm) | D2 in (mm) | D3 in (mm) | D4 in (mm) | n x DS | a in (mm) | Weight lbs | Part No AISI 304 | Part No AISI 316L |
|---------------|---------------|---------------|---------------|---------|--------------|---------------|---------------------|----------------------|
| 1.97 (50) | 1.57 (40) | 4.3 (110) | 5.9 (150) | 4 x 18 | 7.6 (192) | 5.1 | - | 419264 |
| 1.97 (50) | 1.97 (50) | 4.9 (125) | 6.5 (165) | 4 x 18 | 7.7 (195) | 5.9 | - | 419265 |
| 2.95 (75) | 2.56 (65) | 5.7 (145) | 7.3 (185) | 4 x 18 | 9.6 (245) | 7.5 | - | 419266 |
| 4.33 (110) | 3.94 (100) | 7.1 (180) | 8.7 (220) | 8 x 18 | 10.2 (259) | 10.8 | - | 419267 |
| 6.30 (160) | 5.91 (150) | 9.4 (240) | 11.2 (285) | 8 x 22 | 7.9 (200) | 18.7 | - | 419540 |
| 7.87 (200) | 7.87 (200) | 11.6 (295) | 13.4 (340) | 12 x 22 | 9.4 (240) | 27.1 | - | 419541 |

Note: Further flange information available on request.

Access Units

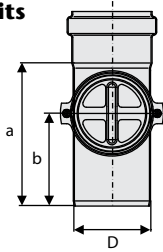

| D in (mm) | a in (mm) | b in (mm) | Weight lbs | Part No AISI 304 | Part No AISI 316L |
|--------------|--------------|--------------|---------------|---------------------|----------------------|
| 2.95 (75) | 5.5 (139) | 3.5 (90) | 1.1 | 98913 | 98963 |
| 4.33 (110) | 7.2 (183) | 4.6 (117) | 1.8 | 98915 | 98965 |
| 4.92 (125) | 8.3 (210) | 5.3 (135) | 2.0 | 419783 | 419785 |
| 6.30 (160) | 11.3 (288) | 7.2 (184) | 5.1 | 98917 | 98967 |
| 7.87 (200) | 11.5 (293) | 7.3 (186) | 8.1 | 419676 | 419678 |

Rat Stop

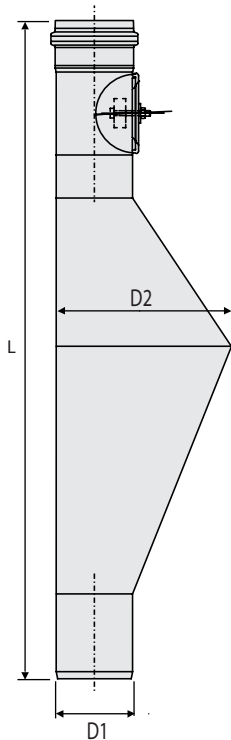

| D1 in (mm) | D2 in (mm) | L in (mm) | Weight lbs | Part No AISI 304 | Part No AISI 316L |
|---------------|---------------|--------------|---------------|---------------------|----------------------|
| 4.33 (110) | 250 (4.33) | 34.1 (864) | 8.4 | 419268 | 419270 |

Vent Cows

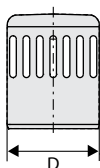

| D in (mm) | Weight lbs | Part No AISI 304 | Part No AISI 316L |
|--------------|---------------|---------------------|----------------------|
| 4.33 (110) | 0.9 | - | 98962 |

EPDM seals are supplied as standard.
For more aggressive applications, FPM & NBR seals are available. Contact ACO.

Installation – Pipe Assembly

Installation of ACO Pipe® should be in accordance with the recommendations below and with AS/NZ3500.

Ensure that all tools are in good condition, electric tools and leads must have current safety tags. Pipe stands must be stable to carry the pipe with no movement and there must be no carbon steel or abrasive material in contact with the stainless steel pipe material.

Pipe Assembly

The assembly of pipe joints is quick and straightforward, requiring only a light application of lubricant (see page 20) to the chamfered pipe end.

1. Make sure both ends are clean and free of dirt.
2. Make sure that the correct seal is in place (see pages 20 and 26).
3. Ensure that the mating ends of the pipes and fittings are clean and free from contamination. Push-fit the pipe end into the socket but do not wedge into the socket recess. Use a half rotational movement to the right and left as the pipes come together.
4. When the pipes are fully engaged, pull the pipes back 0.25" - 0.50" (6 mm to 12 mm) to allow for thermal expansion. With a 60° temperature rise, stainless steel expands at a rate of 0.036" per yard (0.99 mm per meter).

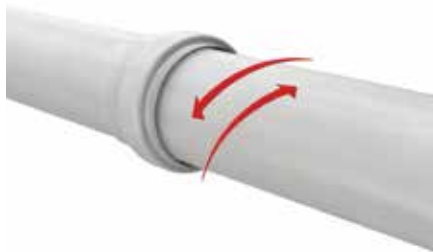

Pipe Cutting

If it is necessary to adapt or shorten pipe lengths, then the cut must be square, clean and ready chamfered. Cutters are available from ACO (see page 23). These tools are designed to form the edge bevel on the male spigoted end of the pipe.

Carbon steel wheels are not permitted.



Pipework Support Details

Horizontal Pipework

The discretion of the installer should be applied to ensure that the pipe is adequately supported. Generally, when the pipe is full of water, the vertical deflection of the pipe between brackets should not exceed 0.06" (1.5 mm).

As a guide, use table below for bracket spacing on horizontal pipes.

| Pipe Diameter in (mm) | Bracket Spacing ft (m) |
|--------------------------|---------------------------|
| 1.97 (50) | 6.56 (2.0) |
| 2.95 (75) | 7.54 (2.3) |
| 4.33 (110) | 8.20 (2.5) |
| 4.92 (125) | 9.84 (3.0) |
| 6.30 (160) | 9.84 (3.0) |
| 7.87 (200) | 9.84 (3.0) |

Vertical Pipework

The load applied with fluid in the pipe is vertical. Position the highest bracket adjacent to the top inlet of the pipe, then mount brackets at 9'-10" (3 meter) spacings. At the bottom of the vertical pipe, use a bracket within 8" (200 mm) of the bottom. Fit brackets at each change of pipework direction or junction points.

The venting of vertical stacks shall be in compliance with AS/NZ3500.

pipework should be at least 1.4" (35 mm) from the wall to facilitate maintenance and painting.

Minimum and Maximum Pipe Weights

To assist designers and installers with the selection of appropriate pipe supports, the table below sets out the weights for all pipe sizes.

| Pipe Diameter in (mm) | Pipe Weight lbs/ft (kg/m) | |
|--------------------------|------------------------------|--------------|
| | Empty | Full |
| 1.97 (50) | 0.81 (1.2) | 2.02 (3.0) |
| 2.95 (75) | 1.21 (1.8) | 4.64 (6.9) |
| 4.33 (110) | 1.81 (2.7) | 8.00 (12.9) |
| 4.92 (125) | 2.22 (3.3) | 10.68 (15.9) |
| 6.30 (160) | 3.36 (5.0) | 16.53 (24.6) |
| 7.87 (200) | 5.04 (7.5) | 25.53 (38.0) |



Parts Tables - Installation Accessories

AP Socket Clamps

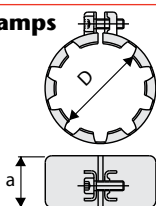

| D1 in (mm) | a in (mm) | Weight lbs | Part No AISI 304 | Part No AISI 316 |
|---------------|--------------|---------------|---------------------|---------------------|
| 1.97 (50) | 1.6 (40) | 0.2 | 417066 | 417067 |
| 2.95 (75) | 1.6 (40) | 0.5 | 417068 | 417069 |
| 4.33 (110) | 1.7 (43) | 0.7 | 417226 | 417227 |

AP Socket Clamps

- two part

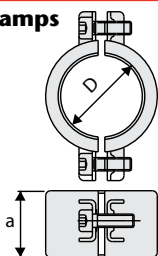

| D1 in (mm) | a in (mm) | Weight lbs | Part No AISI 304 | Part No AISI 316 |
|---------------|--------------|---------------|---------------------|---------------------|
| 4.92 (125) | 1.8 (45) | 0.8 | 417016 | 417017 |
| 6.30 (160) | 1.8 (45) | 1.0 | 417030 | 417031 |
| 7.87 (200) | 1.8 (45) | 1.1 | n/a | 419983 |

AP Pipe Seals (See page 26)

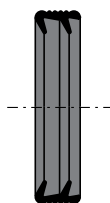

| Nominal Diameter in (mm) | Weight lbs | Part No EPDM | Part No FPM | Part No NBR |
|-----------------------------|---------------|-----------------|----------------|----------------|
| 1.97 (50) | 0.02 | 98400 | 98404 | 417037 |
| 2.95 (75) | 0.04 | 98401 | 98405 | 417038 |
| 4.33 (110) | 0.11 | 98402 | 98406 | 417039 |
| 4.92 (125) | 0.13 | 419453 | 419454 | 417041 |
| 6.30 (160) | 0.18 | 98403 | 98407 | 417040 |
| 7.87 (200) | 0.22 | 98433 | 98437 | 417042 |

Note: Spare ACO Pipe® seals are available for all pipe sizes. All seals incorporate the unique ACO Pipe® double lip seal arrangement for increased reliability and security. Both seal materials are mechanically interchangeable thereby facilitating easy on-site upgrade from EPDM to FPM, for example. For seal installation instructions, refer to the appendices. To aid identification, the seals are colour coded as follows: EPDM seals are BLACK. FPM seals are GREEN. NBR seals are BLACK.

ACO Universal Lubricant

| Unit | Weight lbs | Part No |
|--------|---------------|-----------|
| Tube | 0.3 | E80350000 |
| Bucket | 2.2 | E80350001 |

ACO Pipe® Manual Cutter 50-110 mm



| | Weight lbs | Part No |
|-------------------------------|---------------|---------|
| Manual cutter in plastic case | 7.7 | 419363 |
| Replacement discs* | 0.01 | 419365 |

* Note: Minimum order quantity – 10 pieces

AP Pipe Manual Cutters



| | Weight lbs | Part No |
|--|---------------|---------|
| Ø50-110 manual cutter | 2.2 | 419364 |
| Ø110-160 manual cutter | 4.4 | 400738 |
| Ø160-250 manual cutter | 4.4 | 417228 |
| Replacement discs for use with all size cutters* | 0.1 | 400578 |

Note: AP Pipe Manual Cutters must be ordered in conjunction with AP Holders.

* Minimum order quantity – 10 pieces

AP Holders for Manual Cutting

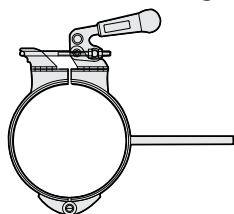

| | Weight lbs | Part No |
|------|---------------|---------|
| Ø125 | 7.7 | 419857 |
| Ø160 | 8.8 | 400742 |
| Ø200 | 9.9 | 400743 |

Note: AP Holders must be ordered in conjunction with AP Pipe Manual Cutters.

* Minimum order quantity – 10 pieces

Installation Hardware

AP Fixing Plates

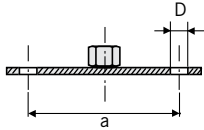

| D in (mm) | a in (mm) | Weight lbs | Part No Galv Steel | Part No AISI 316L |
|--------------|--------------|---------------|-----------------------|----------------------|
| 8.4 (0.33) | 2.8 (70) | 0.1 | 400525 | 400521 |

AP Support Brackets with Rubber Infill

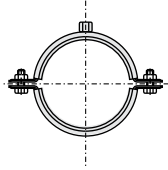

| D in (mm) | Weight lbs | Part No Galv Steel | Part No AISI 316L |
|--------------|---------------|-----------------------|----------------------|
| 1.97 (50) | 0.02 | 400533 | 400529 |
| 2.95 (75) | 0.04 | 400534 | 400530 |
| 4.33 (110) | 0.11 | 400535 | 400531 |
| 4.92 (125) | 0.13 | 419854 | 419855 |
| 6.30 (160) | 0.18 | 400536 | 400532 |
| 7.87 (200) | 0.22 | 419451 | 419675 |

AP Support Brackets with Rubber Infill and Stirrup

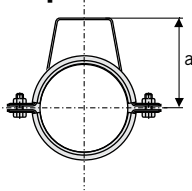

| D in (mm) | a in (mm) | Weight lbs | Part No Galv Steel | Part No AISI 316L |
|--------------|--------------|---------------|-----------------------|----------------------|
| 1.97 (50) | 2.2 (56) | 0.4 | 400541 | 400537 |
| 2.95 (75) | 3.1 (80) | 0.6 | 400542 | 400538 |
| 4.33 (110) | 4.6 (116) | 0.9 | 400543 | 400539 |
| 6.30 (160) | 6.5 (166) | 1.1 | 400544 | 400540 |

AP Support Brackets with Rubber Infill and Key

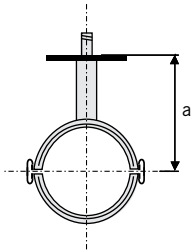

| D in (mm) | a in (mm) | Weight lbs | Part No Galv Steel | Part No AISI 316L |
|--------------|--------------|---------------|-----------------------|----------------------|
| 1.97 (50) | 4.7 (120) | 0.4 | 400549 | 400545 |
| 2.95 (75) | 5.2 (133) | 0.6 | 400550 | 400546 |
| 4.33 (110) | 5.9 (150) | 0.8 | 400551 | 400547 |
| 6.30 (160) | 6.9 (175) | 1.0 | 400552 | 400548 |

AP Threaded Support Poles M8

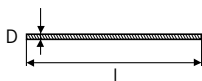

| D in (mm) | a in (mm) | Weight lbs | Part No Galv Steel | Part No AISI 316L |
|--------------|--------------|---------------|-----------------------|----------------------|
| MB | 39.4 (1000) | 0.86 | 400557 | 400553 |
| MB | 3.5 (90) | 0.07 | 400558 | 400554 |
| MB | 1.6 (40) | 0.04 | 400559 | 400555 |

AP Set for Axial Fixing

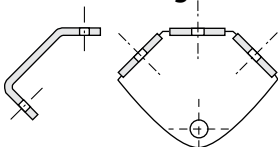

| Weight lbs | Part No Galv Steel | Part No AISI 316L |
|---------------|-----------------------|----------------------|
| 0.24 | 400565 | 400561 |

Installation – Pipework Protection

Installation of ACO Pipe® should be in accordance with the recommendations below and with AS/NZ3500.

Below Ground Installation

When pipework is to be installed in the ground, place the pipe in a sandy bed of 3" (75 mm) (minimum thickness) free of small gravel, sticks, etc. The sand should be free of chlorides and salt.

During installation, avoid scratching surface of the stainless with carbon steel. Avoid subjecting stainless steel pipes to welding and grinding airborne hot particles, metal shavings, and chemicals which may cause corrosion.

Soil Cover

Where pipework is to be installed beneath a water table, apply the following soil depths:

| Pipe Diameter - 50, 75, 110 | |
|---|-----|
| Low density soil 0.94 lbs/ft ³ (15kg/m ³) | 16" |
| High density soil 1.44 lbs/ft ³ (23kg/m ³) | 15" |
| Pipe Diameter - 125, 160, 200 | |
| Low density soil 0.94 lbs/ft ³ (15kg/m ³) | 23" |
| High density soil 1.44 lbs/ft ³ (23kg/m ³) | 26" |

Where ground is permanently cold as experienced in some northern areas, then the drainage may need to be heated.

In general, the minimum permissible depth to avoid winter freezing of water is 32" (800 mm). Note this recommendation is applicable where the ground thaws during spring and becomes warmer during summer.

Backfilling around the pipe can only start when the position of the pipe has been checked and approved.

Structural Penetrations

Where it is necessary for pipework to pass through the walls, structural decking or floors with waterproofing, the ACO Apex Wall Seal system is available, contact ACO.

Socket Clamps

ACO Pipe® pipes and fittings include push-fit socket joints. These will not be able to resist internal pressure beyond design limits (0.5 bar) unless precautions are made to ensure that the joints do not slide open.

In most cases, appropriate fixing to the building can overcome this. If it is difficult, or impossible to fix pipes to the building, socket clamps (see page 22) can prevent the push-fit sockets and spigot ends from sliding open in the event of overload, or the generation of excessive internal pressure.

ACO Pipe® socketed joints with socket clamps can withstand the following pressures:

| Pipe Diameter in (mm) | Maximum Pressure bar |
|-----------------------|----------------------|
| 1.97 (50) | +2 |
| 2.95 (75) | +2 |
| 4.33 (110) | +2 |
| 4.92 (125) | +2 |
| 6.30 (160) | +1 |
| 7.87 (200) | +1 |

Negative pressure (vacuum) applications of up to -0.8 bar can be accommodated.



Care and Maintenance

All grades of stainless steel will stain and discolour due to surface deposits and can never be 100% maintenance free. In order to achieve maximum corrosion resistance, the surface of the stainless steel must be kept clean.

Factors Affecting Maintenance

Surface contamination and the formation of deposits must be prevented in order to maintain a durable and hygienic surface.

These deposits may be minute particles of iron or rust from other materials used on the building site which have come in contact with the pipework. Care must be taken to avoid the cutting of carbon steels—including rebar—and the storage and erection of scaffolding, near the pipework. Industrial and even naturally occurring atmospheric conditions can produce deposits that can also be corrosive, e.g. salt deposits from marine conditions.

The working environment can also produce corrosive conditions e.g. high humidity, such as in a swimming pool, increasing the speed of discolouration and therefore requiring maintenance to be carried out on a more frequent basis. Many cleaners, sterilizers and bleaches, when used in accordance with manufacturers' instructions are safe, but if used incorrectly (e.g. warm or concentrated), they can cause discoloration and corrosion on the surface of any quality of stainless steel.

Strong acid solutions are sometimes used to clean masonry and tiles but they should never be permitted to come into contact with metals, including stainless steel. If this should happen the acid solution must be removed immediately by dousing with clean water.

Wire brushes and wire wool must not be used to remove marks or cement spillage as this can introduce iron impurities onto the material surface.



| Problem | Cleaning Agent | Comment |
|------------------------------------|--|---|
| Routine cleaning | Soap or mild detergent and water (such as washing up liquid). | Sponge, rinse with clean water, and wipe dry if necessary. |
| Fingerprints | Soap or warm water or organic solvent (e.g. acetone, alcohol). | Rinse with clean water, wipe dry if necessary. |
| Stubborn stains and discolouration | Mild cleaning solutions | Rinse well with clean water and wipe dry. |
| Oil and grease marks | Organic solvents (e.g. acetone, alcohol). | Clean after with soap and water, rinse with clean water and dry |
| Rust and other corrosion products | Oxalic acid. The cleaning solution should be applied with a swab and allowed to stand for 15–20 minutes before being washed away with water. | Rinse well with clean water (precautions for acid cleaners should be observed). |

Seal Material Data

ACO Pipe® sockets are fitted with EPDM seals as standard for regular drainage applications. For particularly aggressive applications, FPM and NBR seals are available (see page 20). Refer to the table below to assess suitability and then contact ACO.

EPDM (Ethylene Propylene Diene Monomer)

EPDM was originally developed during the 1950s for vehicle tire applications. It reached wider applications because of its suitability for outdoor use.

FPM (Fluoroelastomer)

FPM is a fluorocarbon and the best material for resistance to hostile chemical and oil environments at normal and elevated temperatures. This material is widely used in the chemical and pharmaceutical industries, but is significantly more expensive than EPDM.

NBR (Nitrile rubber)

NBR has good water resistance, excellent chemical resistance and durability.



Seal Assembly Replacement or Upgrade

The double lip seal is easily removed and replaced from the female end of all ACO Pipe® pipes and fittings. This allows for easy upgrade of the seal material prior to installation.

Seal Installation Notes

1. If changing the seal, ensure the correct size and grade of seal is selected for the application (see table below).
2. Ensure the seal itself and the zone around the pipe and/or fitting receiving the seal is clean, dry and free from dust, grit and any metallic particles.
3. Insert the dry seal into the pipe and/or fitting recess. NOTE: the seal MUST be inserted so the double sealing lips face away from the opening of the pipe and/or fitting.
4. Do not use tools to aid the assembly process otherwise damage to the pipes, fittings and seals may occur.

| Problem | | EPDM | FPM | NBR |
|----------------------------|----------------------------------|----------------------------------|------------------------------|----------------------------------|
| Water Resistance | | Excellent | Good | Good |
| Chemical Resistance | Acids Bases | Good Good | Excellent Good | Excellent Good |
| Solvent Resistance (68°F) | Alcohol Acetone Benzene | Good Good Unsatisfactory | Good Unsuitable Good | Good Unsuitable Unsuitable |
| Oil Resistance | ASTM Oil No. 1 @ 68°F @ 212°F | Fair Unsatisfactory | Excellent 302°F Excellent | Excellent 302°F Good |
| | ASTM Oil No. 3 @ 68°F @ 212°F | Unsatisfactory Unsatisfactory | Excellent 302°F Excellent | Excellent 302°F Good |
| Fuel Resistance | ASTM Fuel B @ 68°F | Unsatisfactory | Excellent | Excellent |
| Resistances | Oxidation Ozone & Weathering | Excellent Outstanding | Outstanding Outstanding | Outstanding Low |
| Heat Resistance | Maximum Continuous | 266°F | 401°F | 176°F |
| | Maximum Intermittent | 302°F | 572°F | 212°F |
| Low Temperature Resistance | | - 58°F | - 4°F | - 22°F |
| Gas Permeability | | Fairly Low | Very Low | Very Low |
| Physical Strength | | Good | Good | Good |
| Compression Set Resistance | | Good | Good | Good |
| Tear & Abrasion Resistance | | Good | Good | Good |
| Cost Factor (1 = low) | | 1 | 20 | 2 |

Glossary

Flow rate - quantity of liquid evacuated through outlet in a given time frame - gallons per minute (GPM).

Pickled & passivated - chemical descaling and coating of stainless steel part to restore corrosion and chemical resistance qualities.

Point load - load exerted through a specific area for specification and testing purposes.

Seal - flexible, EPDM seal between connecting components. Supplied in EPDM (Ethylene Propylene Diene Monomer) material as standard. FPM (Fluoroelastomer) and NBR (Nitrile rubber) available for more aggressive environments. See page 26 for details.

Socket - section of pipe used for connection; a pipe is inserted into a recessed area (socket)

Spigot - straight end section of pipe, used for connection.

Other ACO products

External drainage

ACO Drain

Modular trench drain systems for commercial, industrial and landscape applications.

ACO Sport

Surface drainage and building accessories for track & field.

ACO Infrastructure

Surface drainage products engineered for highways, urban roads and bridges.

Aquaduct

Custom design and manufacture of fiberglass trench drain systems.

ACO Duct

Linear ducting system with removable solid covers.

ACO Environment

Oil water separators and spill containment systems.

ACO Wildlife

Tunnel and fence system to guide amphibians and other small creatures safely across roads.

ACO StormBrixx

A unique and patented plastic geocellular storm water management system.

ACO Self

Simple drainage and building components for use around the home, garden and office.

Building drainage

ACO Stainless

Stainless steel trench drains.

ACO Floor Drain

Stainless steel point floor drains.

ACO BuildLine

Drainage products for thresholds, balconies, green roofs and building façades.

ACO Pipe

Stainless steel push-fit pipe system.

ACO ShowerDrain

Shower drainage.

QuARTz

Designer bathroom floor solutions.



ACO, Inc.

West Sales Office

825 W. Beechcraft St.
Casa Grande, AZ 85122
Tel: (520) 421-9988
Toll Free: (888) 490-9552
Fax: (520) 421-9899

Northeast Sales Office

9470 Pinecone Drive
Mentor, OH 44060
Tel: (440) 639-7230
Toll Free: (800) 543-4764
Fax: (440) 639-7235

Southeast Sales Office

4211 Pleasant Road
Fort Mill, SC 29708
Toll Free: (800) 543-4764
Fax: (803) 802-1063

Electronic Contact:

info@acousa.com
www.acousa.com

© May 2018 ACO, Inc.

All reasonable care has been taken in compiling the information in this document. All recommendations and suggestions on the use of ACO products are made without guarantee since the conditions of use are beyond the control of the company. It is the customer's responsibility to ensure that each product is fit for its intended purpose and that the actual conditions of use are suitable. ACO, Inc. reserves the right to change products and specifications without notice.

Re-order Part # BD015 v1.0

